

OPERATION MANUAL

POWER METER ML83A

VHF TO MICROWAVE BAND POWER SENSOR

MA72A/B, MA73A

MILLIMETER WAVE BAND SENSOR MP

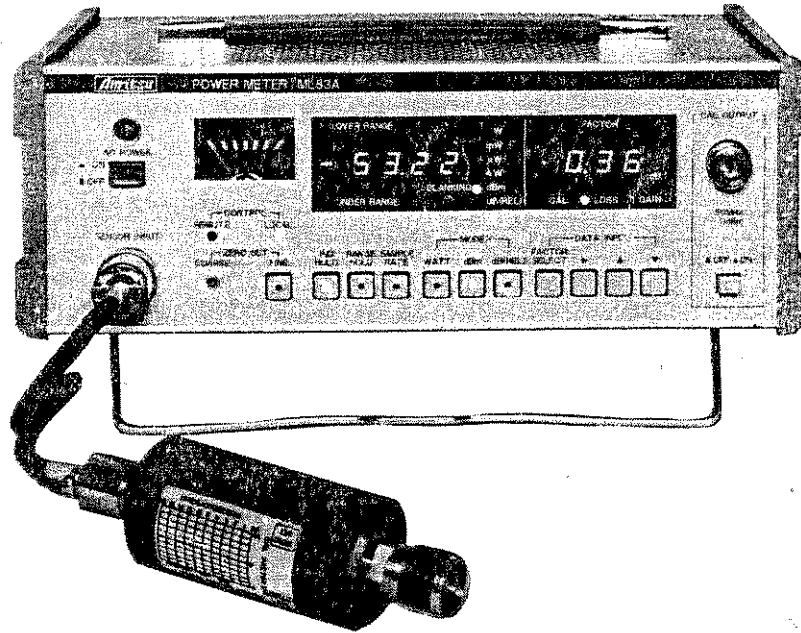

ANRITSU ELECTRIC CO., LTD.

TOKYO, JAPAN

(5) Quasi millimeter wave band Sensor with special order flange is suffixed like MP712A_, MP713A_, etc. All specifications of these Sensors are same as those of standard model Sensors.

Specifications of Sensors for quasi millimeter wave band is shown as following table to be inserted in Table 2-4.

Sensors for quasi millimeter wave band

Model	MP737A	MP738A	MP712A_	MP713A_	MP714A_
Frequency range (GHz)	17 to 22	21.7 to 33	38 to 26.5	26.5 to 40	33 to 50
Flange	Refer to flange list				
Max.VSWR	1.6	1.5	1.6	1.5	
Measuring power range	-20 to +20 dBm (10 μ W to 100 mW)				
Safety power	+23 dBm (200 mW)				
Calibration frequency (GHz)	17, 18, 19, 20, 21, 22	21.7, 23, 25, 27, 29, 31, 33	18, 20, 22, 24, 26.5	26.5, 28, 30, 34, 36, 38, 40	30, 40, 50
Dimensions	ϕ 51 x 103L mm				ϕ 52 x 78L mm
Weight	\leq 450 g				\leq 700 g

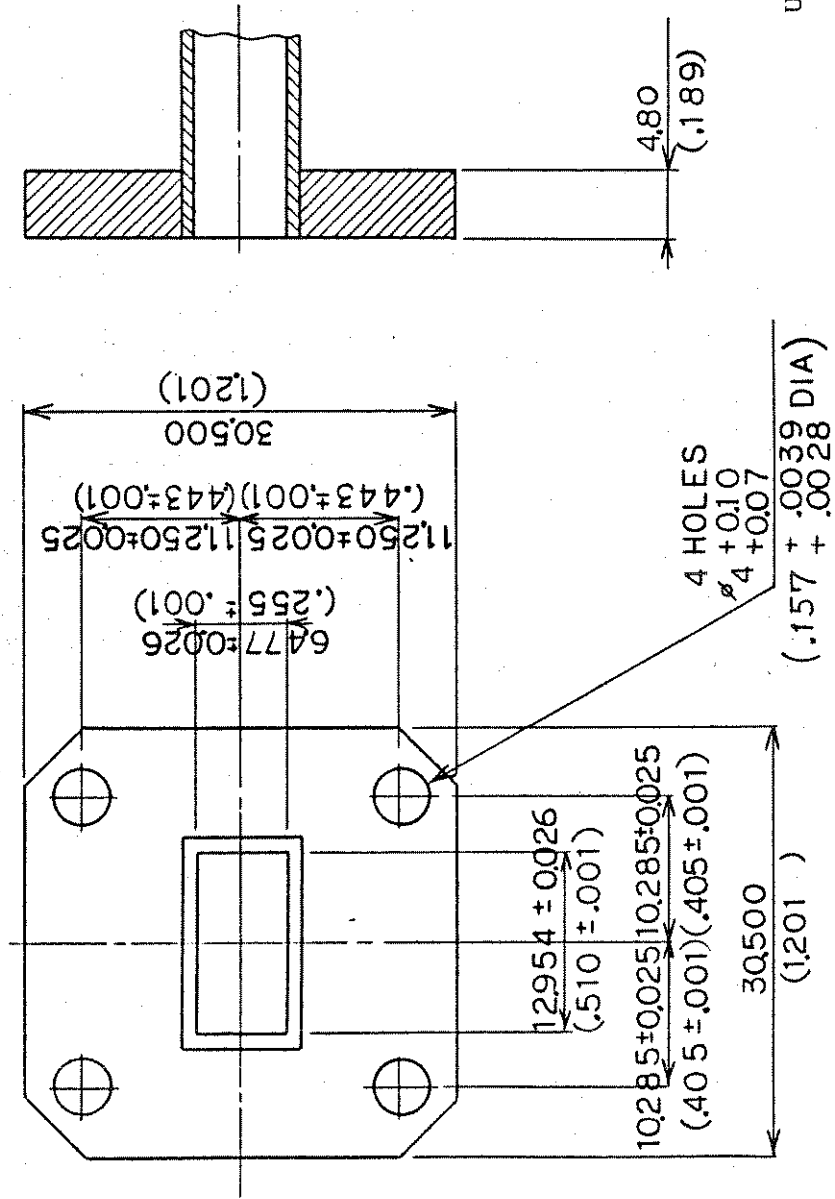

Unit : mm
(inch)

DIMENSIONS OF FLANGE USED WITH MP737A

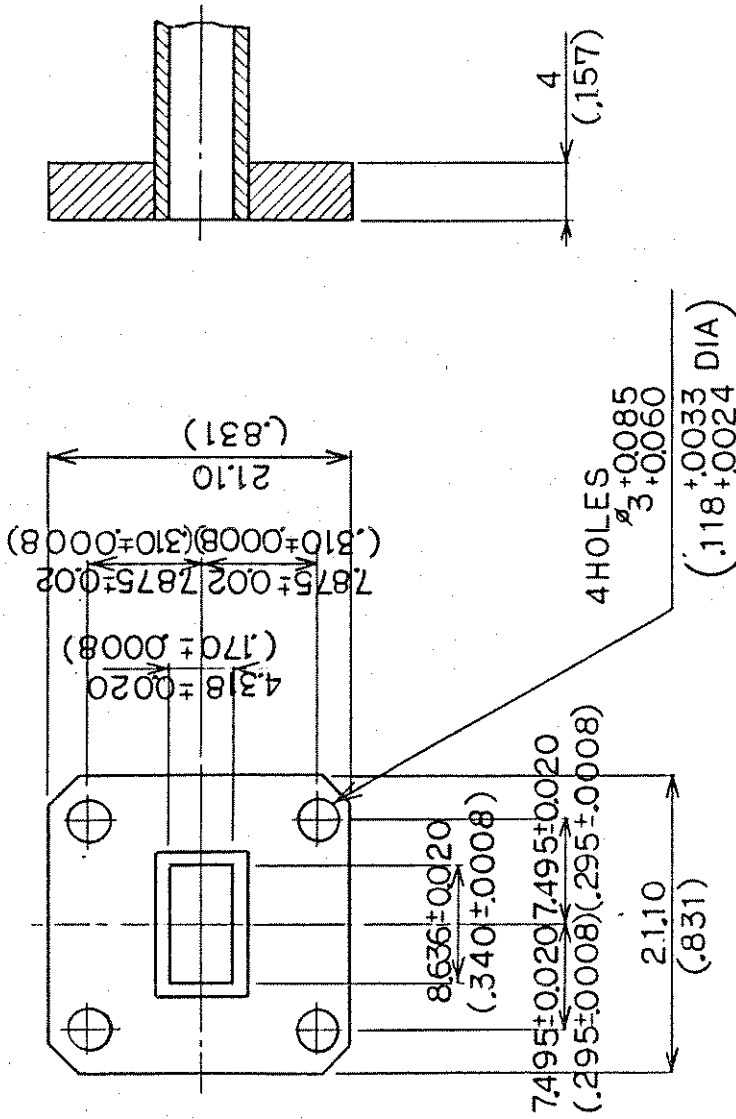

Unit : mm
(inch)

DIMENSIONS OF FLANGE USED WITH MP738A

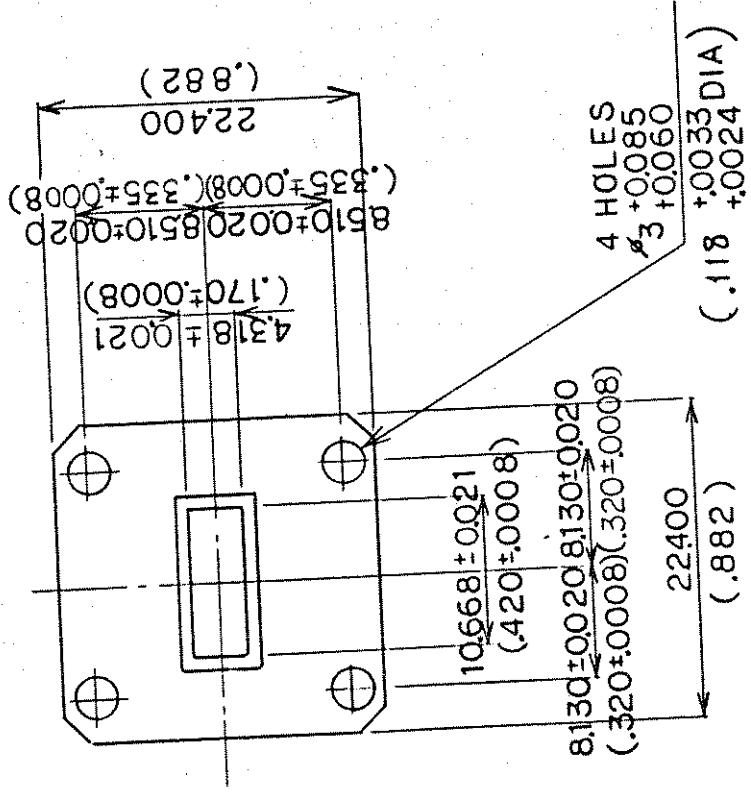
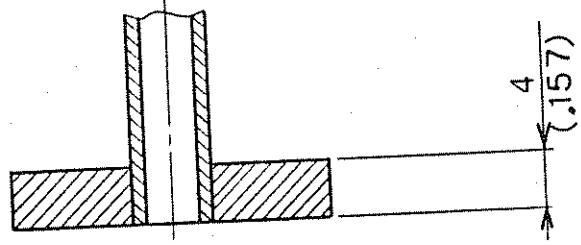

Unit : mm
(inch)

DIMENSIONS OF FLANGE USED WITH MP712A

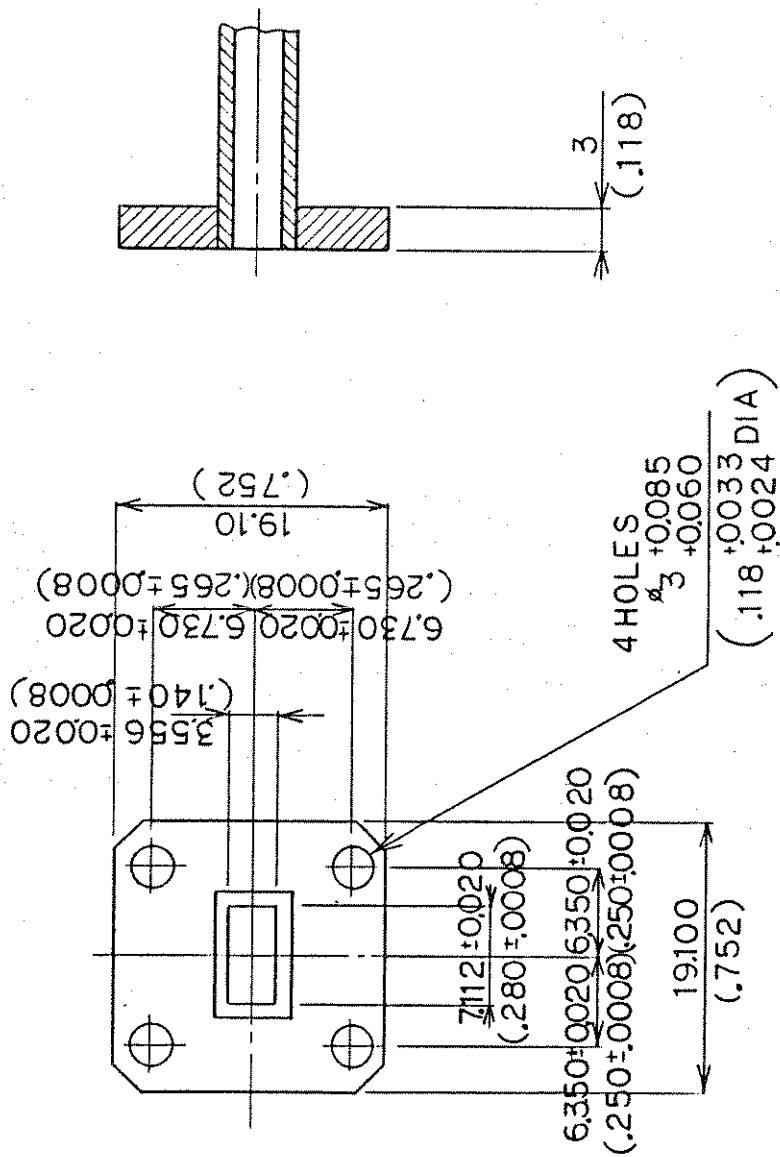

Unit : mm
(inch)

DIMENSIONS OF FLANGE USED WITH MP713A

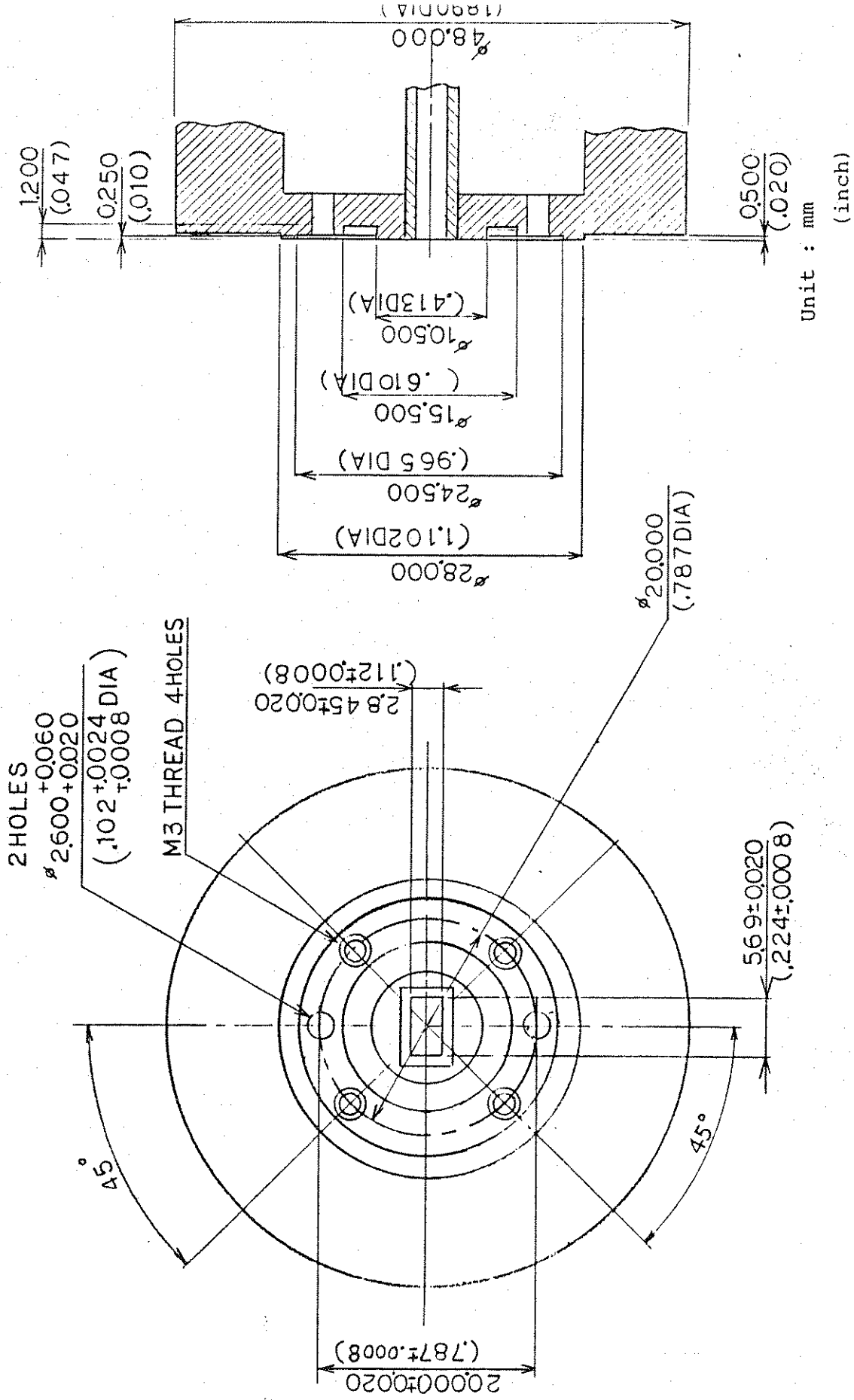

DIMENSIONS OF FLANGE USED WITH MP714A

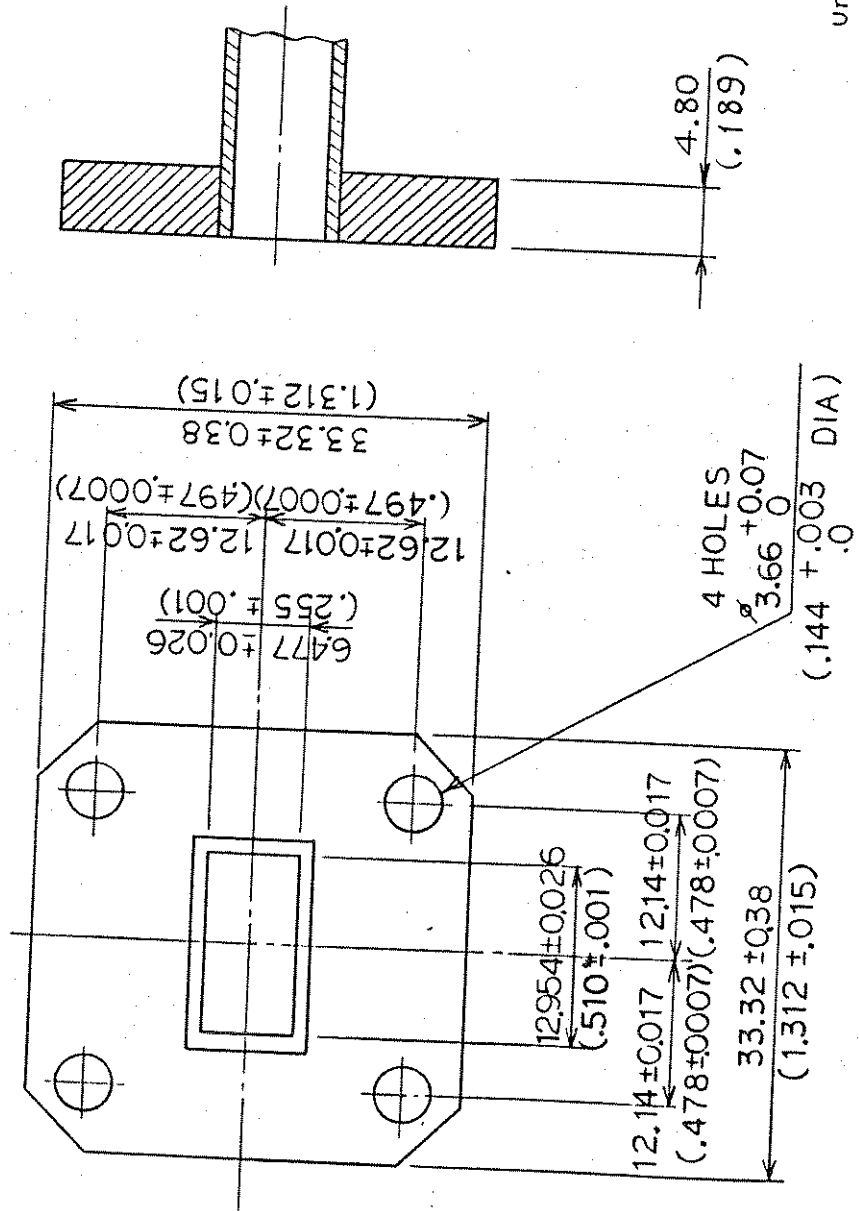

Unit : mm
(inch)

DIMENSIONS OF FLANGE USED WITH MP737A1

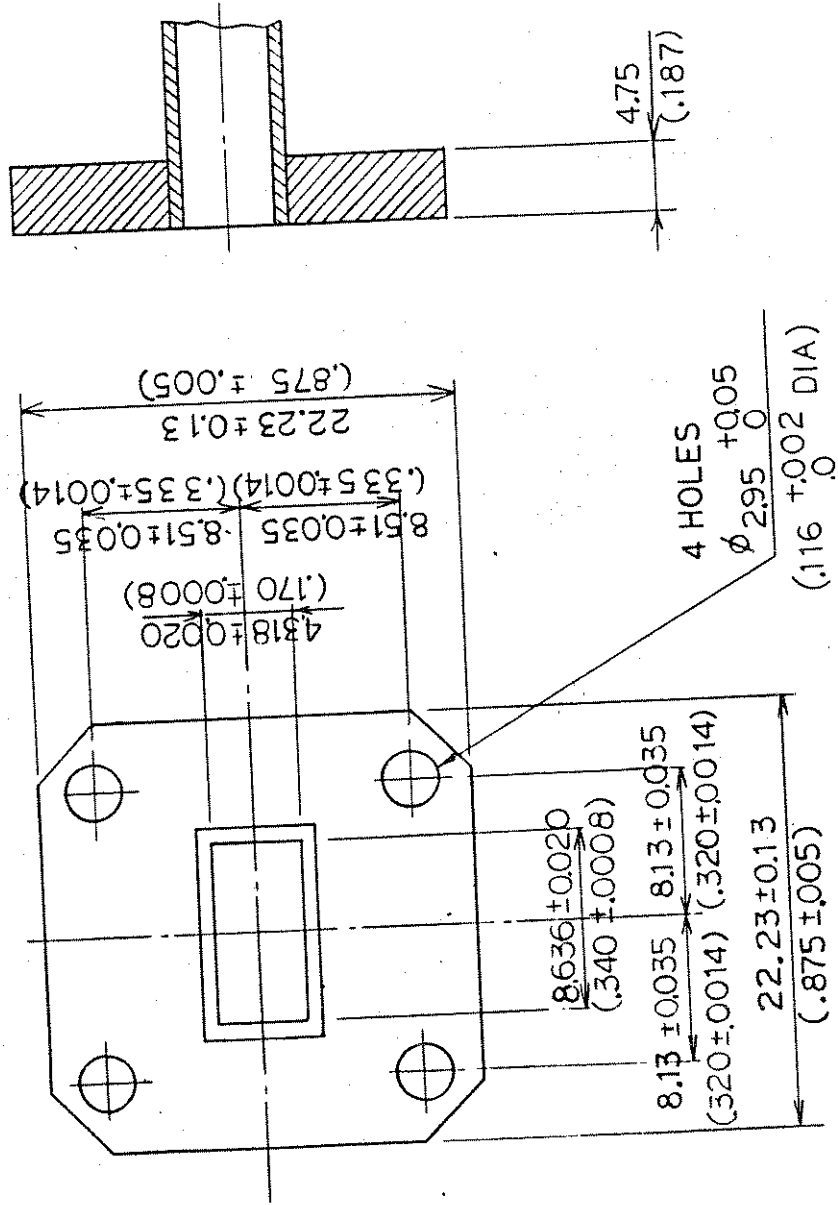

Unit : mm (inch)

DIMENSIONS OF FLANGE USED WITH MP738A1

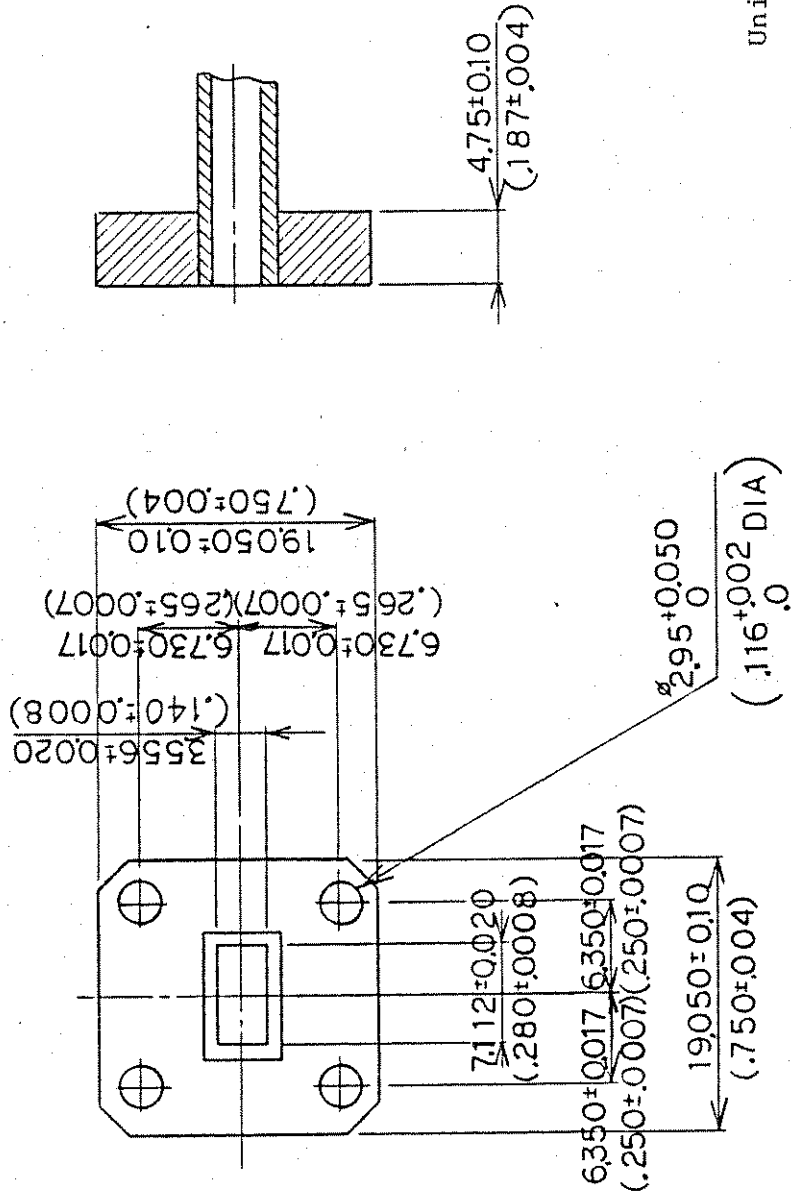

Unit : mm

(inch)

DIMENSIONS OF FLANGE USED WITH MP713A1

4-40 UNG-2B THREAD
 4 HOLES C BORE
 3.6 DIA X 0.8 DEPTH

(.140 DIA x .030 DEPTH)

2 ALIGNMENT PINS
 MARKED P

$\varnothing 1.562_{-0.013}^0$
 (.0615 \pm .0005 DIA)

2 HOLES MARKED H

$\varnothing 1.700_{+0.0025}^0$
 (.067 \pm .001 DIA)

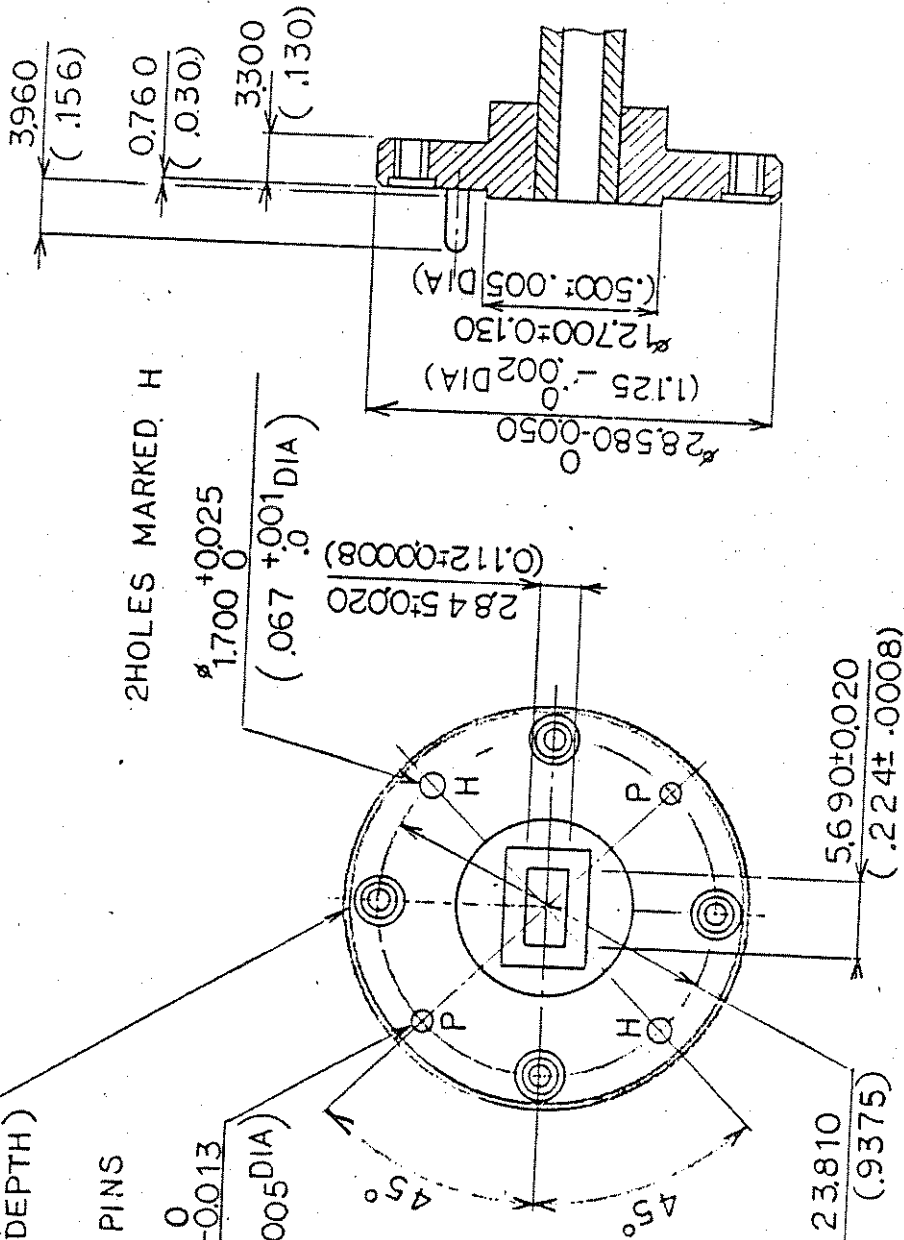

Unit : mm
 (inch)

DIMENSIONS OF FLANGE USED WITH MP714A1

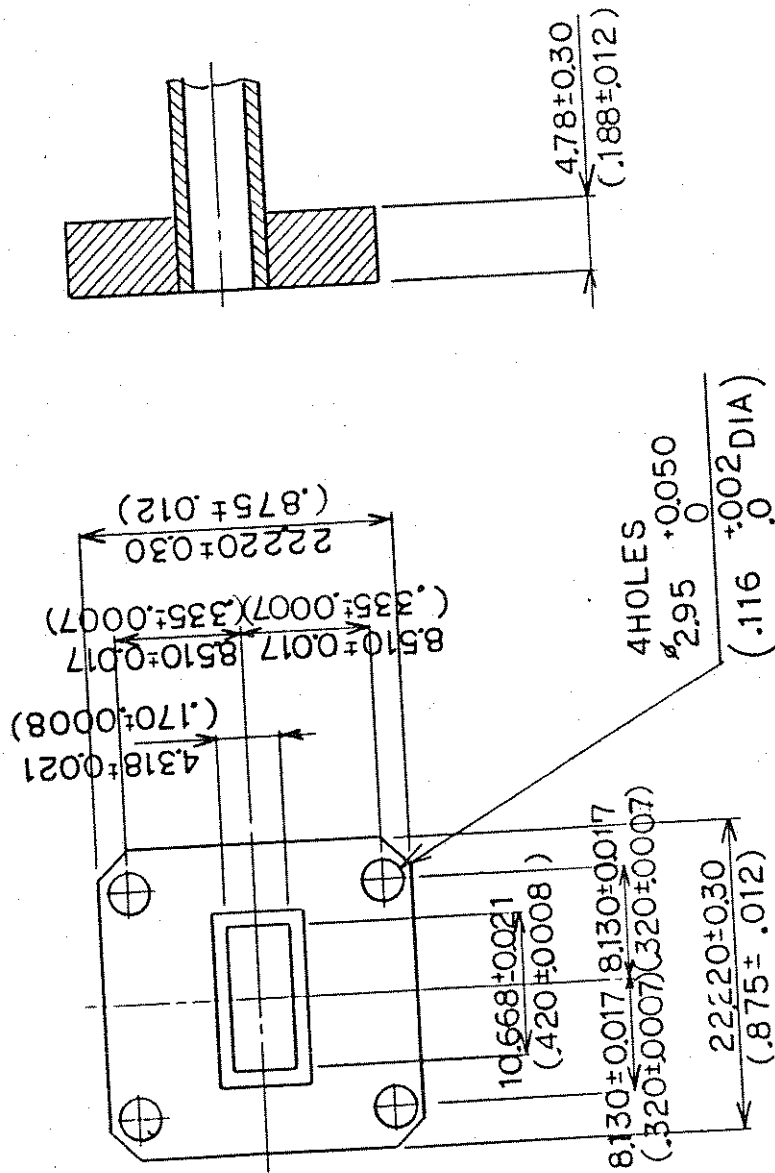

Unit : mm
(inch)

DIMENSIONS OF FLANGE USED WITH MP712A4

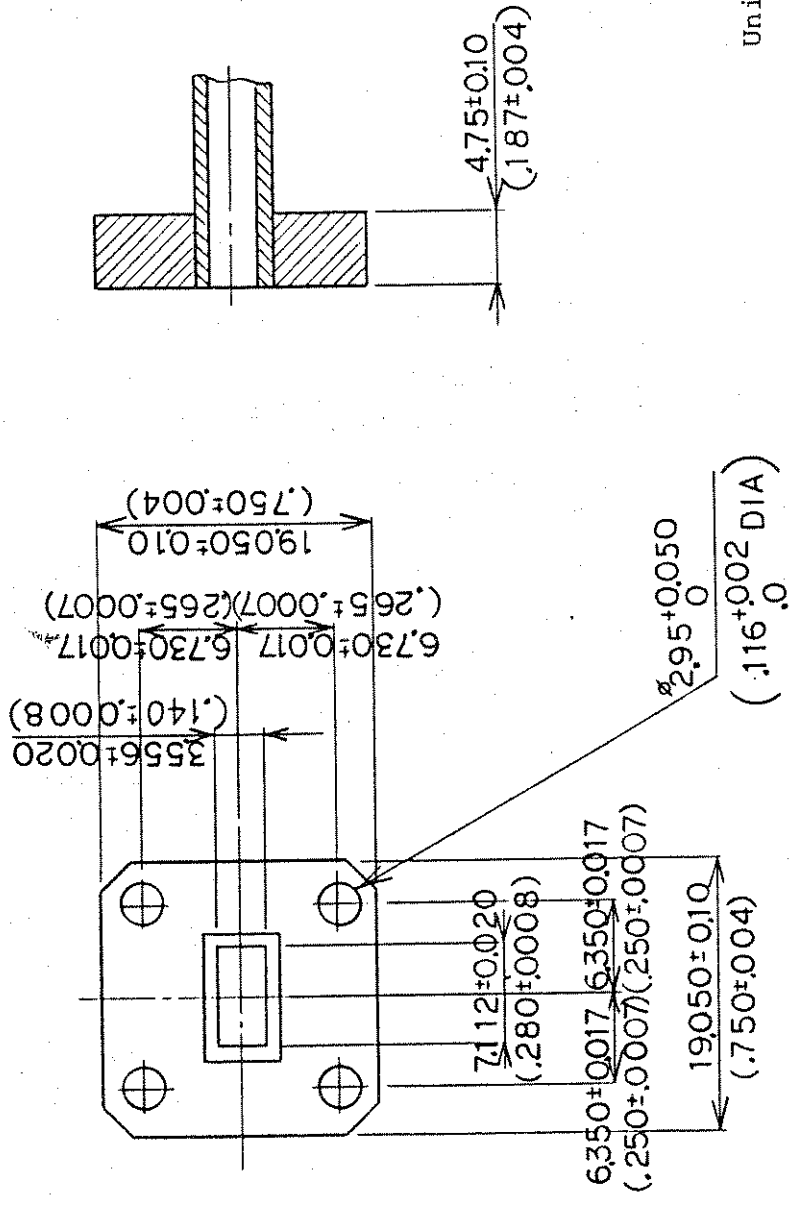

Unit : mm
(inch)

DIMENSIONS OF FLANGE USED WITH MP713A4

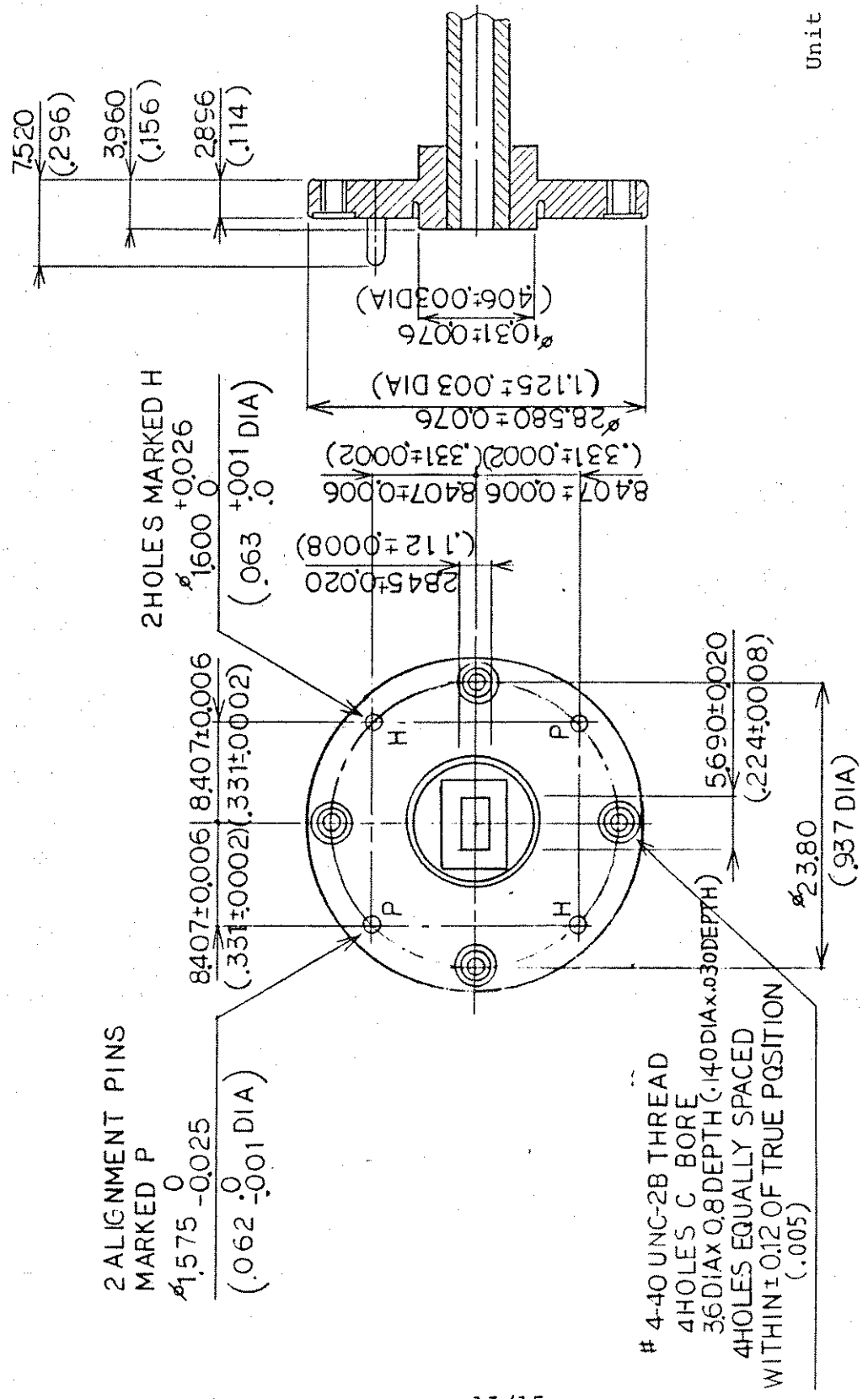

Unit : mm (inch)

DIMENSIONS OF FLANGE USED WITH MP 714A4

CONTENTS

	Page
SECTION 1 GENERAL DESCRIPTION	1-1
SECTION 2 CONFIGURATION AND SPECIFICATIONS	2-1
2.1 Configuration	2-1
2.1.1 Standard Configuration	2-1
2.1.2 Optional Unit	2-3
2.1.3 Optional Accessories	2-3
2.1.4 Peripheral Devices for the ML83A	2-4
2.2 Specifications	2-5
SECTION 3 PRINCIPLES OF OPERATION	3-1
3.1 Block Diagram	3-1
3.2 MA72A/B, MP <input type="checkbox"/> Sensor	3-1
3.2.1 Working Temperature of Thermocouple Junction	3-1
3.2.2 Linearity	3-3
3.2.3 Influence of Fluctuation in Ambient Temperature	3-3
3.2.4 Maximum Power	3-3
3.2.5 Moisture	3-3
3.2.6 Sensor Operation	3-4
3.3 MA73A Sensor	3-4
3.4 ML83A Power Meter	3-5
3.4.1 Input Circuit	3-5
3.4.2 Chopper Drive Signal Generator	3-5
3.4.3 AC Amplifier	3-5

CONTENTS (Cont'd)

	Page
3.4.4 Phase Detector and Low-Pass Filter	3-6
3.4.5 DC Amplifier	3-6
3.4.6 CPU Circuit	3-6
SECTION 4 OPERATION	4-1
4.1 Safety	4-1
4.2 Operating Environment	4-1
4.3 Power Supply	4-2
4.3.1 AC Power Supply	4-2
4.3.2 DC Power Supply	4-2
4.4 The Control Panel	4-3
4.5 Preparation for Measurement	4-12
4.5.1 Connection	4-12
4.5.2 Power Supply Connection	4-12
4.5.3 Operation Check	4-14
4.6 Measurement	4-20
4.7 Calibration of Millimeter Wave Band Sensor MP <input type="checkbox"/>	4-26
SECTION 5 GPIB (OPTIONAL UNIT)	5-1
5.1 Outline	5-1
5.2 Interface Function	5-1
5.3 GPIB System Outline	5-2
5.3.1 Outline	5-2
5.3.2 Description of Bus Line	5-4
5.3.3 Three-Wire Handshake	5-6

CONTENTS (Cont'd)

	Page
5.4 Handling	5-9
5.4.1 Setting Address Switch	5-9
5.4.2 Cable Connection	5-11
5.5 Programming Codes and Output Data Format	5-12
5.5.1 Programming Codes	5-12
5.5.2 Output Data Format	5-15
5.6 Operation Examples	5-17
5.6.1 Measurement in TALK ONLY Mode	5-17
5.6.2 Automatic Measurement	5-18

Vertical text on the left edge, possibly a page number or header, appearing as a faint, dark line.



SECTION 1
GENERAL DESCRIPTION

This device consists of the ML83A Power Meter and the MA72A/B, MA73A, and MP Sensors. It measures power in the microwave to millimeter wave bands with high accuracy and displays the measured values digitally.

The power range which can be measured by this device depends on the sensor used:

- o MA73A Sensor: -60 to -20 dBm (1 nW to 10 μ W)
- o Other sensors: -20 to +20 dBm (10 μ W to 100 mW)

Since the ML83A Power Meter can be combined with any sensor, it can measure a wide range of frequencies (10 MHz to 140 GHz).

This device has these important features as shown below.

- o Wide band
The ML83A covers frequencies from 10 MHz to 140 GHz by combining the power meter with several types of sensors.
- o Wide range of power measurement
The -60 to +20 dBm power can be measured in frequency range from 10 MHz to 18 GHz by combining the power meter with the MA72A/B or MA73A Sensor.
- o Multiple functions
 - Averaging to improve readout accuracy of low levels
 - Automatic zero adjustment
 - Setting on the front panel of calibration coefficient, attenuation and gain compensating value of the measuring system.
 - Measurement of relative power.

- Holding of the indicated value.

Holding in measurement range as well as in auto-range.

- Usable at any place because of operation with a power supply of ac, dc, or the battery.

- GP-IB interface (option)

For automatic measurement by remote control.

- Battery operation

The Battery Pack MZ95A is exclusively used.

- Excellent interchangeability

The power meter can be connected to any sensor without adjustment, which can be selected to suit the purpose.

- Small dimensions and light weight

Convenient shape and light weight for good portability.

SECTION 2

CONFIGURATION AND SPECIFICATIONS

2.1 Configuration

2.1.1 Standard Configuration

Tables 2-1 and 2-2 and Figures 2-1 and 2-2 show the standard configuration of the ML83A power meter and the MA72A/B, MA73A, and MP sensors.

Table 2-1 Standard Configuration of ML83A

Name	Quantity	Remarks
ML83A Power Meter	1 unit	
Instruction manual	1 copy	
Sensor-connecting cord	1 piece	This is supplied only when this power meter is combined with the MA72A/B or MA73A Sensor.
Power cord		Approx. 2.5 m
Fuses	1 set	Contents of 1 set: 2A fuse 1 piece ***A fuse ... 2 pieces

Table 2-2 Standard Configuration of MA72A/B, MA73A, and MP Sensor

Name	Quantity	Remarks
Sensor		
MA <input type="checkbox"/>	1 unit	
MP <input type="checkbox"/>	each	

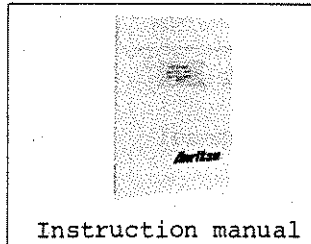
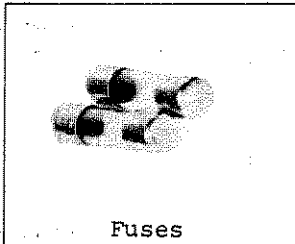
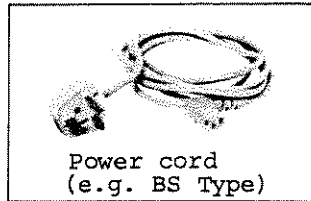
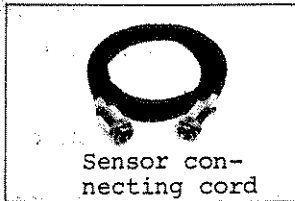
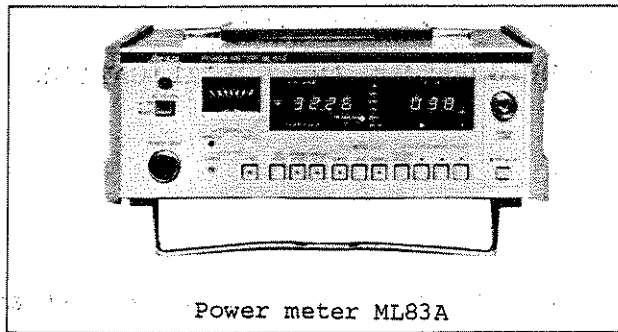

Fig. 2-1 Standard Configuration of ML83A

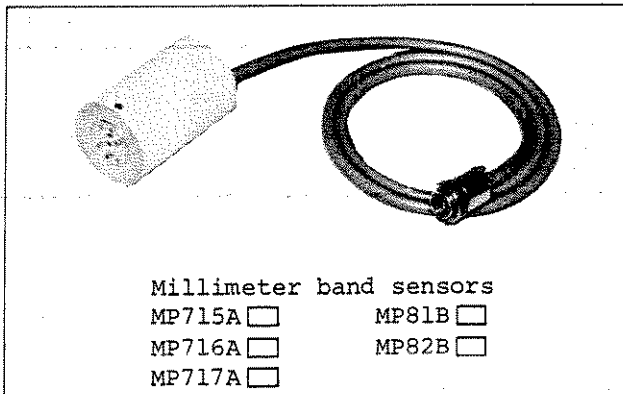
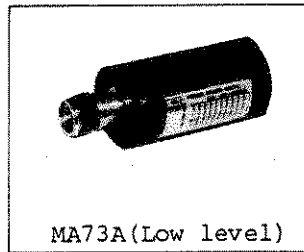
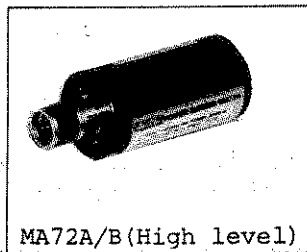

Fig. 2-2 Standard Configuration of Sensors

2.1.2 Optional Unit

GPIB interface

(Fully compatible with IEEE Std. 488-1978. An optional adapting connector for IEC 625-1 is prepared.)

2.1.3 Optional Accessories

- o GPIB Cord

Approx. 2 m long. When the GPIB function is added, this cord connects a peripheral device (such as, personal computer or printer) to the ML83A.

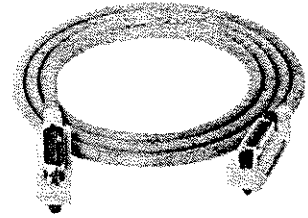

- o Battery Pack

A rechargeable battery that can operate the ML83A continuously for up to 4 hours. This pack can be attached under the ML83A, and the two together are fully portable.



- o Battery Charger

Charges the battery in the MZ95A battery pack.

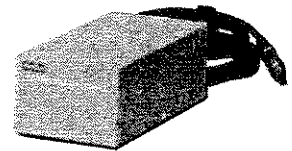

- o 30 dB Attenuator MP47A for sensitivity calibration

A 30 dB fixed attenuator MP47A used to calibrate when the MA73A Sensor is calibrated.



- o Coaxial Attenuator MP721

The Fixed Attenuator MP721 are used for level adjustment and impedance characteristics improvement.

- o DC Power-Connecting Cord

Approx. 2 m long. This is used when operating the ML83A from an external DC power source.

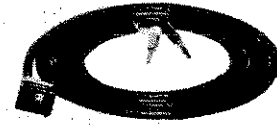

2.1.4 Peripheral Devices for the ML83A

- o PACKET II Personal Computer

This is used as an external controller for the ML83A.

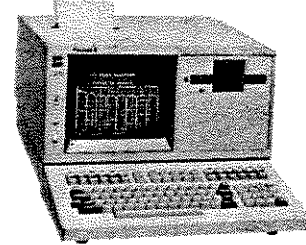

- o DPR7712A Printer

Prints out or tabulates the ML83A's measurements.

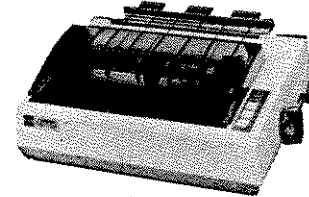

- o DPL7715A Plotter

Plots the ML83A's measurements. Both figures and characters can be plotted.

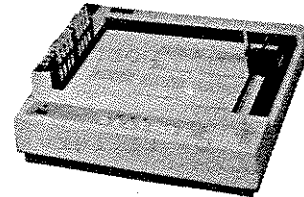

2.2 Specifications

Table 2-3 lists the specifications of the ML83A power meter, and Table 2-4 shows the specifications of each sensor.

Table 2-3 ML83A Specifications

Model	ML83A
Sensors	MA72A/B, MA73A, MP715A <input type="checkbox"/> , MP716A <input type="checkbox"/> , MP81B <input type="checkbox"/> , MP82B <input type="checkbox"/>
Display	W/dBm/dB (REL) selectable Digital in 4 digits With a small analog meter (without numerical readout capacity)
Setting of calibration coefficient and compensating value	Calibration coefficient of the sensor and compensation for attenuation and gain can be input by the pushbuttons, in 0.01 dB steps over the range from 0 to 79.99 dB
Ranges	MA72A/B, MP715A <input type="checkbox"/> /MP716A <input type="checkbox"/> /MP717A <input type="checkbox"/> /MP81B <input type="checkbox"/> /MP82B <input type="checkbox"/> : -10, 0, +10, +20 dBm full scale MA73A: -50, -40, -30, -20 dBm full scale
Range switching	Automatic ranging and the range holding can be performed according to the input power.
Zero adjustment	Coarse and fine adjustment (automatically performed by depressing the pushbutton).
Zero shift between the ranges	$\pm 0.2\%$ of full scale after setting the zero in the maximum sensitivity range.
Response time	Typical value till the displayed value gets 99% of the final value (at the recorder output terminal) Max. sensitivity range: <12 sec. Other ranges: <3.5 sec.
Drift	For 10 minutes under a constant temperature after one hour's warm-up: Max. sensitivity range: $\leq 3\%$ Other ranges: $\leq 1\%$

Table 2-3 ML83A Specifications (Cont'd)

Model	ML83A
Calibrating oscillator	Frequency: 50 MHz Output power: 0 dBm (1mW) Accuracy: $\pm 1.2\%$ Output connector: N(J)
Averaging	Sampling rate time can be set in 3 stages.
Holding indicated value	The indicated value can be held.
Zero set signal output	When FINE zero is selected, the output becomes a TTL low level (0 to 0.25 V). When the zero setting is released, the output becomes a TTL high level (+5 \pm 0.25 V). Connector: BNC
Recorder output	Output impedance 1 k Ω ; A dc voltage output, 0 to 1 V, in proportion to meter deflection. Connector: BNC
Remote control	GP-IB interface incorporated (option)
Power	AC: <input type="checkbox"/> V +10 ₈ , 50/60 Hz, 20 VA -15 ₈ DC: +7 to +12 V, 12 VA When GP-IB is incorporated: AC: 23 VA, DC: 144 VA Continuous operation duration by an external battery: 4 hours
Dimensions	99 H, 282 W, 200 D mm
Weight	≤ 3.5 kg

Table 2-4 Specifications of Sensors

VHF to Microwave Band Sensors

Model	MA72A	MA72B	MA73A
Frequency range	10 MHz to 14 GHz	10 MHz to 18 GHz	
Impedance	50 Ω		
Max. VSWR	1.4	10 MHz to 14 GHz 1.4 14 GHz to 18 GHz 1.5	10 MHz to 50 MHz 1.6 50 MHz to 14 GHz 1.4 14 GHz to 18 GHz 1.6
Measuring power range	-20 to +20 dBm (10 μW to 100 mW)		-60 to -20 dBm (1 nW to 10 μW)
Safety power	+22 dBm (160 mW)		+23 dBm (200 mW)
Calibration accuracy	10 MHz to 12.4 GHz 0.15 dB(3.5%) 12.4 GHz to 14.0 GHz 0.23 dB(5.5%)	10 MHz to 12.4 GHz 0.15 dB(3.5%) 12.4 GHz to 14.0 GHz 0.23 dB(5.5%) 14.0 GHz to 18.0 GHz 0.3 dB(7.0%)	10 MHz to 50 MHz 0.27 dB(6.5%) 50 MHz to 12.4 GHz 0.19 dB(4.5%) 12.4 GHz to 14.0 GHz 0.29 dB(7.0%) 14.0 GHz to 18.0 GHz 0.33 dB(8.0%)
RF input connector	N(P)		
Dimensions	43 H, 53 W, 88 D mm		
Weight	≤300 g		

Millimeter Wave Band Sensors

Model	MP715A □	MP716A □	MP717A □	MP81B □	MP82B □
Frequency range	40 to 60 GHz	50 to 75 GHz	60 to 90 GHz	75 to 110 GHz	90 to 140 GHz
Flange	Refer to flange list				
Max. VSWR	1.4	1.4	1.4	1.5	1.5
Measuring power range	-20 to +20 dBm (10 μW to 100 mW)				
Safety power*	+23 dBm (200 mW)				
Calibration frequency	40,50,60 GHz	50,60,75 GHz	60,75,90 GHz	75,90,110 GHz	90,110,140 GHz
Dimensions	50 φ × 75 L mm				
Weight	≤700 g (includes 1 mm cord attached on each sensor)				

* Tested with ac equivalent power.

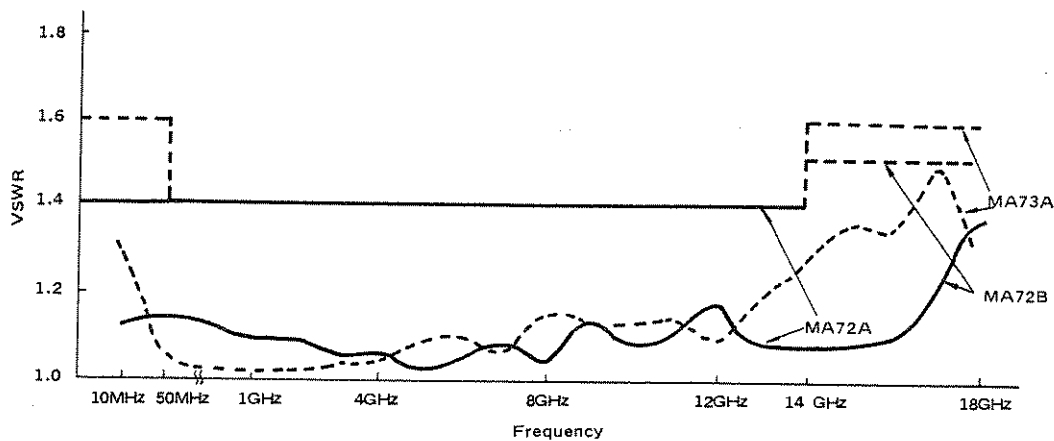

Fig. 2-3 MA72A/B, MA73A Sensor VSWR Characteristic Examples

Tables 2-5 and Fig. 2-4 show the types and dimensions of the flanges which can be used with the millimeter wave band sensor.

Table 2-5 Flange Types

Sensors Model	Type	Flange Dimensions											Fig.	Equivalent Waveguide			
		Dimensions												IEC	JAN	EIA	
		A	B	φC	φD	E	φF	H	φd								
MP715A	BRJ-50	±0.03 4.78	±0.03 2.39	-	-	-	-	-	-	-	-	-	-	-	R-500	-	WR-19
MP716A	BRJ-60	±0.03 3.76	±0.03 1.880	-	-	-	-	-	-	-	-	-	-	-	R-620	RG-98/U	WR-15
MP717A	BRJ-75	±0.02 3.10	±0.02 1.55	-	-	-	-	-	-	-	-	-	-	-	R-740	RG-99/U	WR-12
MP81B	BRJ-95	±0.02 2.540	±0.02 1.270	-	-	-	-	-	-	-	-	-	-	-	R-900	-	WR-10
MP82B	BRJ-MOD	±0.02 2.032	±0.02 1.016	-	-	-	-	-	-	-	-	-	-	-	R-1200	RG-138/U	WR-8
MP715A1	MIL-F-3922/ 67B-007	±0.04 4.78	±0.04 2.39	±0.13 12.70	0 -0.05 28.58	-	-	-	-	-	-	-	-	-	R-500	-	WR-19
MP716A1	MIL-F-3922/ 67B-008	±0.04 3.76	±0.04 1.88	±0.13 9.53	0 -0.05 19.05	-	-	-	-	-	-	-	-	-	R-620	RG-98/U	WR-15
MP717A1	MIL-F-3922/ 67B-009	±0.04 3.10	±0.04 1.55	±0.13 9.53	0 -0.05 19.05	-	-	-	-	-	-	-	-	-	R-740	RG-99/U	WR-12
MP81B1	MIL-F-3922/ 67B-010	±0.04 2.54	±0.04 1.27	±0.13 9.53	0 -0.05 19.05	-	-	-	-	-	-	-	-	-	R-900	-	WR-10
MP82B1	MIL-F-3922/ 74-001-MOD	±0.010 2.03±	±0.010 1.02	±0.05 5.33	±0.015 0 9.576	-	-	-	-	-	-	-	-	-	R-1200	RG-138/U	WR-8
MP715A4	UG-383/U -MOD	±0.020 4.775	±0.020 2.388	±0.076 10.31	±0.076 28.58	±0.006 8.407	±0.076 23.80	±0.076 2.896	±0.076 3.20	±0.076 3.20	±0.076 3.20	±0.076 3.20	±0.076 3.20	-	R-500	-	WR-19
MP716A4	UG-385/U	±0.020 3.759	±0.020 1.880	±0.076 8.33	±0.076 19.05	±0.006 5.055	±0.076 14.275	±0.076 3.20	±0.076 3.20	±0.076 3.20	±0.076 3.20	±0.076 3.20	±0.076 3.20	-	R-620	RG-98/U	WR-15
MP717A4	UG-387/U	±0.020 3.099	±0.020 1.549	±0.076 7.52	±0.076 19.05	±0.006 5.055	±0.076 14.275	±0.076 3.20	±0.076 3.20	±0.076 3.20	±0.076 3.20	±0.076 3.20	±0.076 3.20	-	R-740	RG-99/U	WR-12
MP81B4	UG-387/U -MOD	±0.020 2.540	±0.020 1.270	±0.076 7.52	±0.076 19.05	±0.006 5.055	±0.076 14.275	±0.076 3.20	±0.076 3.20	±0.076 3.20	±0.076 3.20	±0.076 3.20	±0.076 3.20	-	R-900	-	WR-10
MP82B4	UG-387/U -MOD	±0.020 2.032	±0.020 1.016	±0.076 7.52	±0.076 19.05	±0.006 5.055	±0.076 14.275	±0.076 3.20	±0.076 3.20	±0.076 3.20	±0.076 3.20	±0.076 3.20	±0.076 3.20	-	R-1200	RG-138/U	WR-8

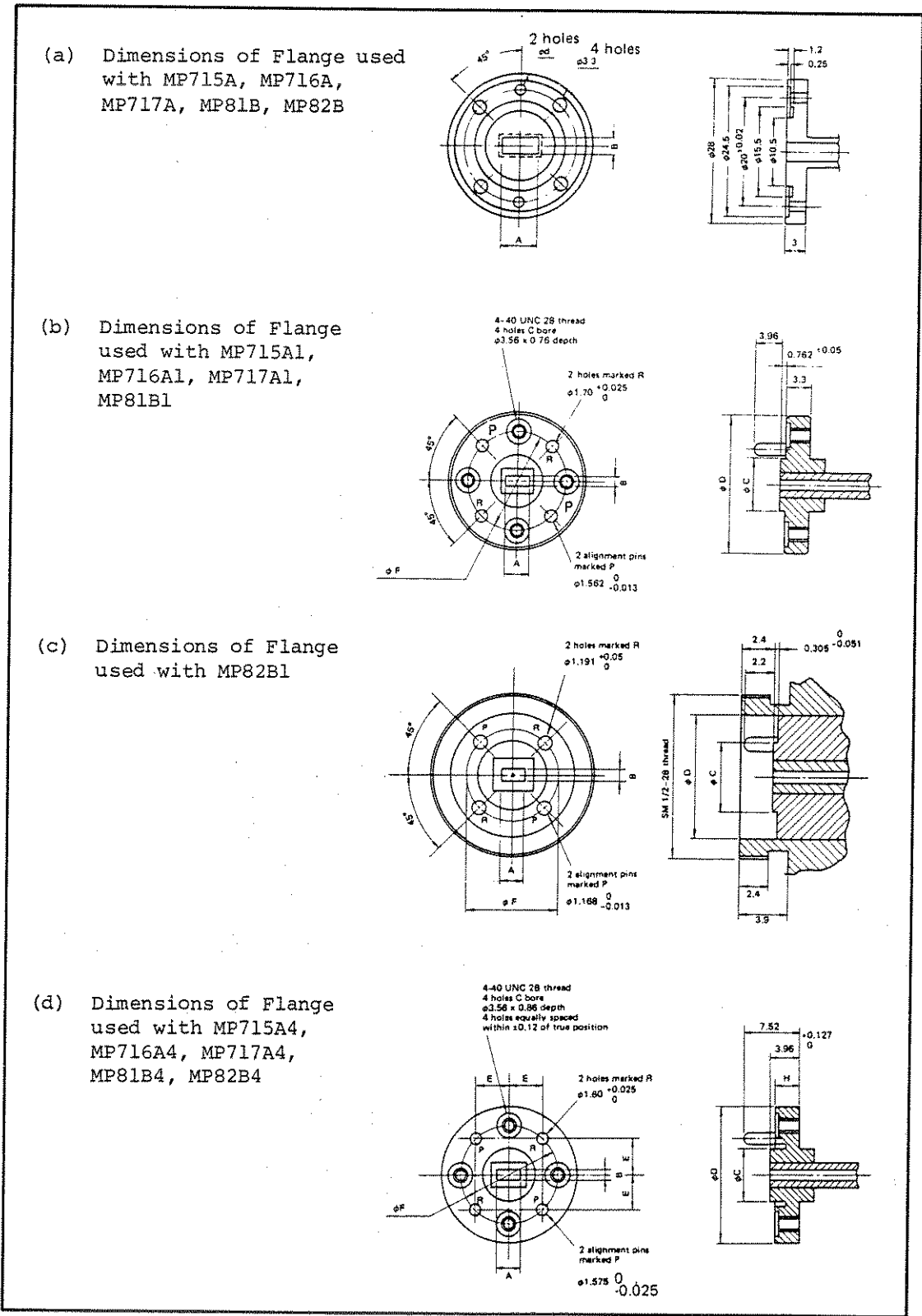

Fig. 2-4 Flange Dimensions

SECTION 3

PRINCIPLES OF OPERATION

3.1 Block Diagram

Fig. 3-1 is a block diagram of the ML83A power meter with sensor.

3.2 MA72A/B, MP Sensor

3.2.1 Working Temperature of Thermocouple Junction

The MA72A/B and MP sensors use a thin-film thermocouple. The microwave or millimeter wave power applied to the sensor is converted by a resistor into heat. This heat is detected as a rise in temperature by the thermocouple and is converted into voltage.

The enclosed thermocouple is an alloy of bismuth and antimony. The thermal e.m.f. E of an antimony-bismuth thermocouple is as follows.

$$E = (117.6 - 0.0009t_m)(t_1 - t_2) \text{ (}\mu\text{V)} \quad (1)$$

where

t_1 and t_2 : temperatures of both junctions

t_m : average temperature of t_1 and t_2

However, since a thin-film type thermocouple is used in this instrument, E is only 70 to 80% of the e.m.f. shown in equation (1). Therefore, the approximate expression of the e.m.f. of this thermocouple is represented by equation (2).

$$E = 88 (t_1 - t_2) \text{ (}\mu\text{V)} \quad (2)$$

The DC output voltage is approx. $600\mu\text{V}$ with an RF input of 10mW . Therefore, the temperature rise of the junction is approx. 7°C with the 10mW input of equation (2).

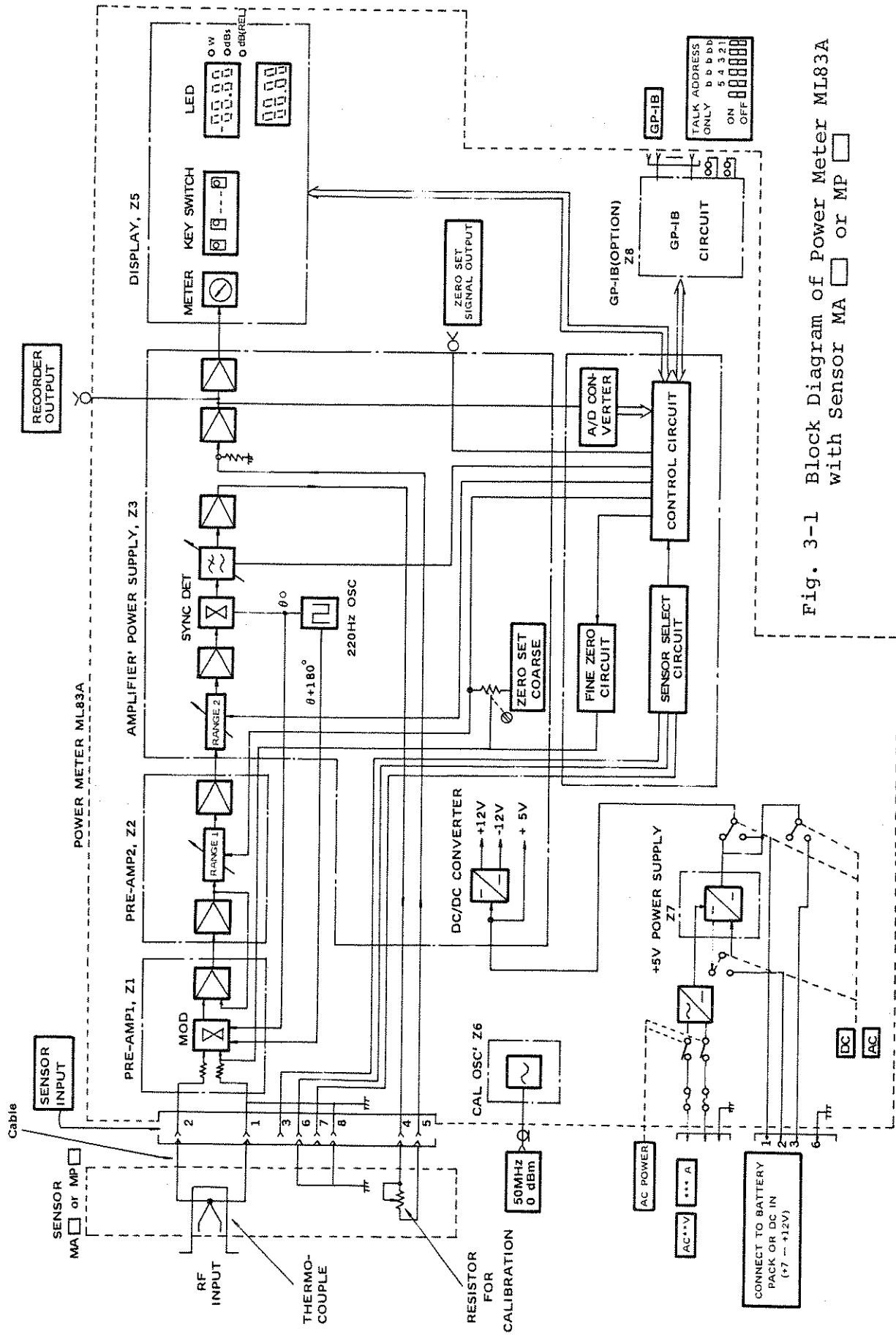

Fig. 3-1 Block Diagram of Power Meter ML83A with Sensor MA or MP

3.2.2 Linearity

It is assumed that $(t_1 - t_2)$ is proportional to the input RF power in equation (1). Therefore, only the term containing t_m affects the linearity. The coefficient of t_m is unknown in the thin-film thermocouple, but the order of magnitude can be calculated from equation (1). According to this method, the deviation in linearity is approx. 4×10^{-5} with a 10mW input, making the t_m term negligible in practice.

3.2.3 Influence of Fluctuation in Ambient Temperature

Since the coefficient of t_m is unknown in the thin-film thermocouple as discussed in par. 3.2.2, the order of magnitude is calculated using equation (1). This gives a value of approx. $1 \times 10^{-5} / ^\circ\text{C}$. Actual measurements have yielded values of $-(2 \text{ to } 1.0) \times 10^{-4} / ^\circ\text{C}$.

3.2.4 Maximum Power

As can be seen from par. 3.2.1, the temperature of the junction increases to 70°C with an RF input of 100mW. Up to an approx. 300mW input at normal ambient temperature, there is no change of burn out, but there is a possibility that performance may vary due to high temperature; so avoid applying an excessive power input (more than 100mW) for a long period of time.

3.2.5 Moisture

The thermocouple has insufficient damp-proofness. But since it is sealed, it operates normally at temperatures of up to 40°C and a relative humidity up to 90%.

3.2.6 Sensor Operation

Since the sensitivity of this instrument is calibrated when it is shipped from the factory, RF power can be read directly by simply connecting the cord to the ML83A Power Meter.

Follow these guidelines when operating this instrument.

- (1) When connecting the meter with the system to be measured, screw the knock pin in tightly.
- (2) If the ambient temperature changes sharply, offset voltage will be generated since this instrument uses a thermocouple. Do not change the temperature of the thermocouple housing; for example, do not touch it during measurement.

It is especially important to select a location with minimal room temperature variation when using the high-sensitivity range of -20 to -10 dBm.

- (3) Do not remove the cover from the thermocouple housing because it has a moisture-proof seal (charged with inactive gas). If the element blows, contact Anritsu and return the entire thermocouple assembly.

3.3 MA73A Sensor

MA73A is an extremely sensitive sensor using a low-barrier schottky diode. This sensor can measure true power since this diode always operates within the square-law characteristic range.

The microwave applied to the sensor is detected by this diode, and a DC voltage proportional to the detected power is generated. This voltage is amplified and displayed on the power meter.

3.4 ML83A Power Meter

3.4.1 Input Circuit

The input circuit has been carefully designed since DC output voltage of the sensor is extremely low, approx. $1\mu\text{V}$ when an RF power of -15 dBm is applied to it. The circuit is a DC-AC conversion type based on the electrical chopper, which is considered to be the DC amplification method with the lowest noise and lowest drift at the present stage of technical development. The DC input signal is converted by the chopper to an AC signal of approx. 220 Hz , the drive frequency of the chopper.

In order to minimize the offset voltage generated by changes in ambient temperature, the chopper is made on a small ceramic substrate by using the MIC (Micro Integrated Circuit) technique.

3.4.2 Chopper Drive Signal Generator

220 Hz is selected as the approximate oscillation frequency for these reasons:

- (1) The influence of the power supply frequency (50 or 60 Hz and its higher harmonic components) must be avoided.
- (2) As a high frequency as possible must be selected to avoid the adverse influence of phase rotation in the AC amplifiers and also to reject $1/f$ noise, even if a large coupling capacitor and a by-pass capacitor are not used in the amplifiers.

3.4.3 AC Amplifier

The 220 Hz -chopped signal is amplified by an AC amplifier which uses a linear IC (Z2-Q1, Q8 and Z3-Q2, Q3). The total amplifier gain is calibrated by

using the DC input voltage. For the most sensitive range (-20 to -10 dBm), the recorder output indicates 1.00V, and the Digital Display shows -10.00 dBm when the DC input voltage is 3.16 μ V. Therefore, the total amplifier gain is 110 dB.

3.4.4 Phase Detector and Low-Pass Filter

The phase detector (Z3-Q3), like the sampling gate circuit, is driven by the signal output from the 220 Hz oscillator. The ripple of the output signal from the phase detector is reduced by the low-pass filter.

3.4.5 DC Amplifier

The output from the low-pass filter is applied to the input of the DC amplifier after passing the resistor in the sensor for sensitivity calibration. The output from the DC amplifier is distributed to the RECORDER OUTPUT, to the Meter circuit, and to the A/D converter.

3.4.6 CPU Circuit

CPU circuit consists of an A/D converter, an 8-bit microprocessor, ROM, RAM, and D/A converter. The output signal from the DC amplifier (Z3-Q14) is converted to a 12-bit binary signal by the A/D converter (Z4-Q4).

The microprocessor (Z4-Q14) processes this binary signal to indicate the input level on the digital display in WATT, dBm or dB(REL), aided by the ROM (Z4-Q16, Q17, Q18) and RAM (Z4-Q19, Q20).

The output voltage of the D/A converter (Z4-Q13) is used for the fine zero adjustment.

SECTION 4
OPERATION

4.1 Safety

- (1) To prevent electrical shock, ground the grounding terminal of the ML83A or connect the grounding terminal to a 3-way power outlet that includes a ground.
- (2) Turn off the power and disconnect the power cable from the ML83A before attempting to replace a fuse.
- (3) If this instrument is operated at room temperature after being used or stored for a long period at a low temperature, condensation may cause a short-circuit. To prevent this, do not turn the power on until the instrument is completely dry.
- (4) If an excessively high power was input to the sensor, the sensor or the power meter may be damaged.

A power higher than the maximum input power must not be applied directly to the sensor.

The maximum input power is as follows:

MA72A/B	+22 dBm (160 mW)
MA73A/MP <input type="checkbox"/>	+23 dBm (200 mW)

4.2 Operating Environment

This instrument operates normally at ambient temperatures of 0 to 50°C. It must not be used where there is:

- (1) high vibration
- (2) moisture or dust
- (3) direct sunshine
- (4) active gas

4.3 Power Supply

This instrument normally operates with the following AC or DC power supply:

- o AC ** V $\begin{matrix} +10\% \\ -15\% \end{matrix}$, 50/60 Hz
- o DC +7 to +12 V

4.3.1 AC Power Supply

This instrument can use a 100 to 130 Vac or 200 to 260 Vac power supply by changing the internal power transformer tap connection.

4.3.2 DC Power Supply

This instrument operates normally when the DC power supply satisfying the following conditions is used:

+7 to +12 V, 12 VA
(14.4 VA when GP-IB is incorporated)

4.4 The Control Panel

Figure 4-1 (on a fold-out page located at the last of this manual) shows the front and rear panels. Table 4-1 is a detailed explanation of the functions and operations of the controls and indicators on these panels.

Table 4-1 Controls and Indicators on the Panels

Number	Symbol	Function															
①		Digital display. The measured value is displayed as a 4-digit number with a polarity symbol ("+" or "-").															
②	BLANKING	Deletes the lowest digit of the number displayed at ①.															
③	W, mW, μ W, nW, dBm, dB (REL)	<p>Range and unit display lamps.</p> <p>W, mW, μW, and nW: Indicates WATT mode; and the value displayed at ① is represented in units of W, mW, μW, or nW. The units are selected by the auto range function according to the input level. The relationship between these ranges and sensors is shown below:</p> <table border="1" data-bbox="771 1176 1404 1627"> <thead> <tr> <th>Range</th> <th>MA72A/B and MP <input type="checkbox"/> sensors</th> <th>MA73A sensor</th> </tr> </thead> <tbody> <tr> <td>①</td> <td>+10 to +20 dBm (10mW to 100mW)</td> <td>-30 to -20 dBm (1μW to 10μW)</td> </tr> <tr> <td>②</td> <td>0 to +10 dBm (1mW to 10mW)</td> <td>-40 to -30 dBm (0.1μW to 1μW)</td> </tr> <tr> <td>③</td> <td>-10 to 0 dBm (0.1mW to 1mW)</td> <td>-50 to -40 dBm (100nW to 0.1μW)</td> </tr> <tr> <td>④</td> <td>-20 to -10 dBm (10μW to 0.1mW)</td> <td>-60 to -50 dBm (10nW to 100nW)</td> </tr> </tbody> </table>	Range	MA72A/B and MP <input type="checkbox"/> sensors	MA73A sensor	①	+10 to +20 dBm (10mW to 100mW)	-30 to -20 dBm (1 μ W to 10 μ W)	②	0 to +10 dBm (1mW to 10mW)	-40 to -30 dBm (0.1 μ W to 1 μ W)	③	-10 to 0 dBm (0.1mW to 1mW)	-50 to -40 dBm (100nW to 0.1 μ W)	④	-20 to -10 dBm (10 μ W to 0.1mW)	-60 to -50 dBm (10nW to 100nW)
Range	MA72A/B and MP <input type="checkbox"/> sensors	MA73A sensor															
①	+10 to +20 dBm (10mW to 100mW)	-30 to -20 dBm (1 μ W to 10 μ W)															
②	0 to +10 dBm (1mW to 10mW)	-40 to -30 dBm (0.1 μ W to 1 μ W)															
③	-10 to 0 dBm (0.1mW to 1mW)	-50 to -40 dBm (100nW to 0.1 μ W)															
④	-20 to -10 dBm (10 μ W to 0.1mW)	-60 to -50 dBm (10nW to 100nW)															

Table 4-1 Controls and Indicators on the Panels (cont'd)

Number	Symbol	Function
③	W, mW, μ W, nW dBm, dB (REL)	<p>dBm: Indicates dBm mode; the value displayed at ① is represented in units of dBm.</p> <p>dB (REL): Indicates the dB (REL) mode; a relative value from the stored reference level is displayed at ① in units of dB.</p>
④	FACTOR	<p>Indicates the factor (CAL, LOSS, or GAIN) used to compensate a measured value.</p> <p>When a factor is selected by pressing the FACTOR SELECT key in DATA INPUT ⑦, the lamp corresponding to the selected factor lights up.</p> <p>The data for the selected factor can be input by using the ► ▲ ▼ keys in DATA INPUT ⑦ . □ □ □</p> <p>After entering the data for the factor, the CAL, LOSS, GAIN lamp goes on and off repeatedly.</p>
④	CAL	<p>The value displayed in FACTOR is set as the sensor calibration factor by pressing the ► ▲ ▼ keys in DATA INPUT ⑦ . □ □ □</p> <p>(The calibration factor is a sensor frequency characteristic compensation value. A table of the characteristics is printed on each sensor.)</p> <p>Once this compensation value is set, the calibrated value is displayed at ①.</p>
④	LOSS	<p>When an attenuation element (such as an attenuator or a directional coupler) is inserted between the sensor and a terminal to be measured, the element attenuation value can be stored in the LOSS FACTOR memory by pressing the ► ▲ ▼ keys in DATA INPUT ⑦ . □ □ □</p> <p>The power value to which the attenuation is added is displayed at ①.</p>

Table 4-1 Controls and Indicators on the Panels (cont'd)







Number	Symbol	Function																								
④	GAIN	<p>When an amplifier is inserted between the sensor and a terminal to be measured, the amplifier gain can be stored in the GAIN FACTOR memory by pressing the    keys in DATA INPUT ⑦.  The power value obtained by amplifier gain compensation is displayed at ①.</p>																								
⑤	CAL OUTPUT 																									
⑥	CAL OUTPUT  OFF  ON	<p>When the CAL OUTPUT ON/OFF switch is set to ON, the CAL oscillator is activated and supplies the coaxial system calibration RF output (50 MHz, 0 dBm) through connector ⑤.</p> <p>This function cannot be used for the waveguide system.</p>																								
⑦	DATA INPUT FACTOR SELECT	<p>Selects one factor from CAL, LOSS, and GAIN, and inputs each data.</p> <p>When the power is turned on in the ML83A, the CAL lamp lights up at FACTOR display ④ and initial data 0.00 dB is displayed.</p> <p>Each time the FACTOR SELECT key is pressed, the CAL, LOSS, and GAIN lamps light up by turns as shown below, indicating that data can be input. The data for the corresponding factor is displayed at ④.</p> <table border="1" data-bbox="760 1388 1425 1850"> <thead> <tr> <th>STEP</th> <th>ACTION</th> <th>LAMP INDICATION</th> <th>FACTOR INDICATION</th> </tr> </thead> <tbody> <tr> <td>1.</td> <td>Turn on the power.</td> <td>CAL</td> <td>0.00 dB</td> </tr> <tr> <td>2.</td> <td>Press the FACTOR SELECT key.</td> <td>LOSS</td> <td>0.00 dB</td> </tr> <tr> <td>3.</td> <td>Press the FACTOR SELECT key.</td> <td>GAIN</td> <td>0.00 dB</td> </tr> <tr> <td>4.</td> <td>Press the FACTOR SELECT key.</td> <td>(The indication is blanked. Used when the indication is unnecessary.)</td> <td></td> </tr> <tr> <td>5.</td> <td>Press the FACTOR SELECT key.</td> <td>(Status returns to STEP 1. STEPS (1) to (5) can be performed again by pressing the FACTOR SELECT key repeatedly.)</td> <td></td> </tr> </tbody> </table>	STEP	ACTION	LAMP INDICATION	FACTOR INDICATION	1.	Turn on the power.	CAL	0.00 dB	2.	Press the FACTOR SELECT key.	LOSS	0.00 dB	3.	Press the FACTOR SELECT key.	GAIN	0.00 dB	4.	Press the FACTOR SELECT key.	(The indication is blanked. Used when the indication is unnecessary.)		5.	Press the FACTOR SELECT key.	(Status returns to STEP 1. STEPS (1) to (5) can be performed again by pressing the FACTOR SELECT key repeatedly.)	
STEP	ACTION	LAMP INDICATION	FACTOR INDICATION																							
1.	Turn on the power.	CAL	0.00 dB																							
2.	Press the FACTOR SELECT key.	LOSS	0.00 dB																							
3.	Press the FACTOR SELECT key.	GAIN	0.00 dB																							
4.	Press the FACTOR SELECT key.	(The indication is blanked. Used when the indication is unnecessary.)																								
5.	Press the FACTOR SELECT key.	(Status returns to STEP 1. STEPS (1) to (5) can be performed again by pressing the FACTOR SELECT key repeatedly.)																								

Table 4-1 Controls and Indicators on the Panels (cont'd)

Number	Symbol	Function
	WATT	<p>Pressing the WATT key lights up the LED inside key and selects the WATT mode. The power meter displays the RF input power in watt, milliwatt, microwatt, or nanowatt units.</p>
	dBm	<p>The WATT mode can be cleared by pressing the dBm or dB, (REL) key.</p> <p>Pressing the dBm key lights up the LED inside the key and selects the dBm mode. The power meter displays the RF input power in units of dBm.</p>
	dB (REL)	<p>The dBm mode can be cleared by pressing the WATT or dB (REL) key.</p> <p>Pressing the dB (REL) key lights up the LED inside the key and selects the dB (REL) mode. The value just displayed is stored as a reference value in the memory unit, and "0" appears on the digital display (1). The RF input level relative to the stored reference value is displayed on the power meter in units of dB.</p> <p>The dB (REL) mode can be cleared by pressing the WATT or dBm key.</p>
(9)	SAMPLE RATE	<p>This key is used for averaging.</p> <p>When this key is set to ON, the sampled data is averaged and the averaged value is displayed at (1) in order to reduce fluctuation in the value caused by noise. The relationship between number of data sampled and necessary repetition period is shown below:</p>

Table 4-1 Controls and Indicators on the Panels (cont'd)

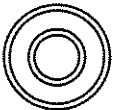
Number	Symbol	Function				
⑨	SAMPLE RATE	STEP	LED inside SAMPLE RATE key	Number of data records to be averaged	Necessary repetition period (seconds)	
		(i) Initial status	Off	(Averaging: off)		
		(ii) Press the SAMPLE RATE key	On	5	Approx. 1.5	
		(iii) Press the SAMPLE RATE key	On	10	Approx. 3	
		(iv) Press the SAMPLE RATE key	On	20	Approx. 6	
		(v) Press the SAMPLE RATE key	(Status returns to (i). STEPs (i) to (v) can be performed again by repeatedly pressing the SAMPLE RATE key.)			
⑩	RANGE HOLD	<p>Selects the auto range function or the range hold function.</p> <p>Pressing this key lights up the LED inside the key and holds the current range. Pressing the key again selects the auto range function, and extinguishes the LED.</p>				
⑪	IND HOLD	<p>When this key is pressed, the value displayed at ① is held and the LED inside the key lights up. In this status, the displayed value cannot be changed by operation from the front panel. When this key is pressed again, the display hold function is reset and the LED inside this key goes off.</p>				
⑫	ZERO SET	<p>Consists of a zero-set coarse adjustment knob and a fine adjustment key.</p> <p>This control is used when a sensor is replaced or the ambient temperature changes sharply to adjust the zero point.</p>				

Table 4-1 Controls and Indicators on the Panels (cont'd)

Number	Symbol	Function
①6	CONTROL	These lamps indicate the ML83A control mode (REMOTE or LOCAL).
	REMOTE	This lamp lights up when the ML83A is controlled externally through the optional GP-IB interface.
	LOCAL	This lamp lights up when ML83A is being controlled from the front panel.
①7		The peaking meter visually indicates an increase and decrease in a measured value.
①8	UNDER RANGE	If the RF input level is higher than the measurement range being used, the OVER RANGE lamp lights up; if the RF input level is too low, the UNDER RANGE lamp lights up.
①9	OVER RANGE	
		When RANGE HOLD is on, these lamps indicate that the level is over or under the range being held.
②0	RECORDER OUTPUT	Connector for recorder output. This connector outputs a DC voltage proportional to the value indicated on the peaking meter ①7.
		Output voltage: 1 V \pm 0.1 V at range full scale (This output voltage is obtained when the load impedance is 100 k Ω or higher and the sensitivity calibration factor, loss data, or gain data was not input.)
②1	ZERO SET SIGNAL OUTPUT	This connector outputs the TTL low-level voltage (0 to 0.25 V) when FINE zero adjustment is being performed. Otherwise, this connector outputs the TTL high-level voltage (+5 \pm 0.25 V). This output can be used to externally turn off the RF input at zero adjustment.
②2		AC/DC switch. Set this switch to the AC position when AC power supply is used; set this switch to the DC position when DC power supply is used.

Table 4-1 Controls and Indicators on the Panels (cont'd)

Number	Symbol	Function
②3	CONNECT TO BATTERY PACK OR EXT DC IN (+7 - +12 V)	<p>Input connector for MZ95A battery pack or external DC power supply. An external DC power supply can be connected with a cord (optional accessory). The DC power supply must be from +7 to +12 V and 12 VA (or 14.4 VA when GP-IB is incorporated).</p> <p>When a DC power supply is connected, set the AC/DC switch ②2 to the DC position.</p>
②4	AC**V	AC power cord receptacle with 2 fuse holders.
②5	***A	
②6		Grounding terminal for chassis
②7	GP-IB (optional)	Interface connector used when external control is performed through the GP-IB interface.
②8	ADDRESS (optional)	Dip switch for address setting, used when control is performed through the GP-IB interface.
②9		Power cord post. The power cord can be wound on these posts for storage or transportation.

4.5 Preparation for Measurement

4.5.1 Connection

This device must be connected in the following procedure:

STEP	PROCEDURE
1.	Connect a sensor to the sensor connecting cord (The MP <input type="checkbox"/> sensor is already connected to the cord.)
2.	Connect the sensor connecting cord to SENSOR INPUT <u>13</u> of ML83A. Note: Turn off the power to the ML83A before connecting the sensor, connecting a sensor to the ML83A while the power is on may damage the sensor.
3.	Connect the sensor to an RF signal to be measured.

4.5.2 Power Supply Connection

AC power supply, MZ95A battery pack, or external DC power supply can be used.

(1) AC power supply connection

STEP	PROCEDURE
1.	Set the AC power switch <u>14</u> to the OFF position.
2.	Set the AC/DC switch <u>22</u> to the AC position.
3.	Check whether or not the line voltage is <input type="checkbox"/> ** Vac $\begin{matrix} +10\% \\ -15\% \end{matrix}$ and that all appropriate fuses have been set.
4.	Connect the AC power receptacle <u>24</u> to the power line with a 3-conductor power cable. Note: If a 3-conductor power cord is not available, ground the grounding terminal <u>26</u> on the rear panel of ML83A in order to prevent electrical shock.

(2) Battery pack MZ95A connection

STEP	PROCEDURE
1.	Set the AC power switch (14) to the OFF position.
2.	Disconnect the AC power cord from the AC power receptacle (24).
3.	Attach the MZ95A battery pack under the ML83A power meter as shown in Fig. 4-2. (Loosen the battery pack fastening screws at both sides of the battery pack, insert them through the tapped holes on the both sides of ML83A, and tighten them down.)

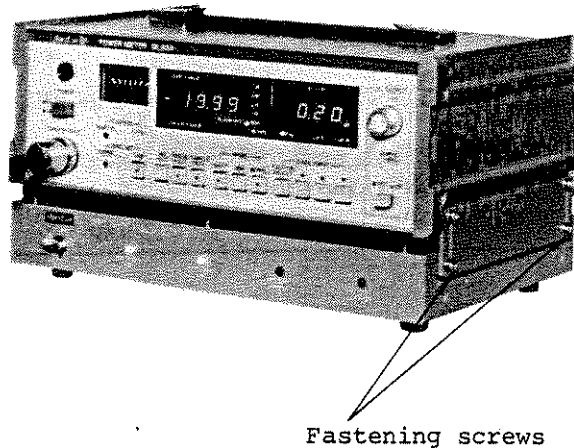

Fig. 4-2 Battery Pack Mounting

4. Set the power switch of the MZ95A battery pack to the OFF position.
5. Connect the battery pack cord to the DC input connector (23).
6. Set the AC/DC switch (22) to the DC position.
7. Set the MZ95A power switch to the ON position. Power is then supplied from the MZ95A to the ML83A. The AC power switch (14) is not operational in this case.

(3) External DC power supply connection

STEP	PROCEDURE
1.	Set the AC power switch (14) to the OFF position.
2.	Disconnect the AC power cord from the AC power receptacle (24).
3.	Check that the output voltage of the external DC power supply unit is in the +7 to +12 V range.
4.	Set the power switch of the external DC power supply to the OFF position.
5.	Connect the external DC power supply unit to the DC input connector (23) with the external DC power cord (optional accessory).
6.	Set the AC/DC switch (22) to the DC position.
7.	Set the power switch of the external DC power supply unit to the ON position. External DC power is then supplied to the ML83A.

3.5.3 Operation Check

This section explains how to check that the ML83A and the MA72A/B or MA73A sensor are operating normally.

This check is useful for an acceptance inspection of the instrument or before using it to take measurements.

STEP	PROCEDURE						
1.	Set the AC power switch (14) to the OFF position.						
2.	Set the AC/DC switch (22) to the AC position.						
3.	Check whether or not the power voltage is <table border="1" data-bbox="493 1545 716 1598"><tr><td>**</td><td>Vac</td><td>+10%</td></tr><tr><td></td><td></td><td>-15%</td></tr></table> and that the appropriate fuses have been set.	**	Vac	+10%			-15%
**	Vac	+10%					
		-15%					

STEP	PROCEUDRE
4.	Connect the AC power receptacle (24) to the power line with a 3-conductor power cord.
	Note: If a 3-conductor power cord is not available, ground the grounding terminal (26) on the rear panel of the ML83A to prevent electrical shock.
5.	Connect a sensor to the SENSOR INPUT connector (13) with the sensor connecting cord.
6.	Set the AC power switch (14) to the ON position.
7.	Turn on the power and check that initialization occurs, as shown in Fig. 4-3.

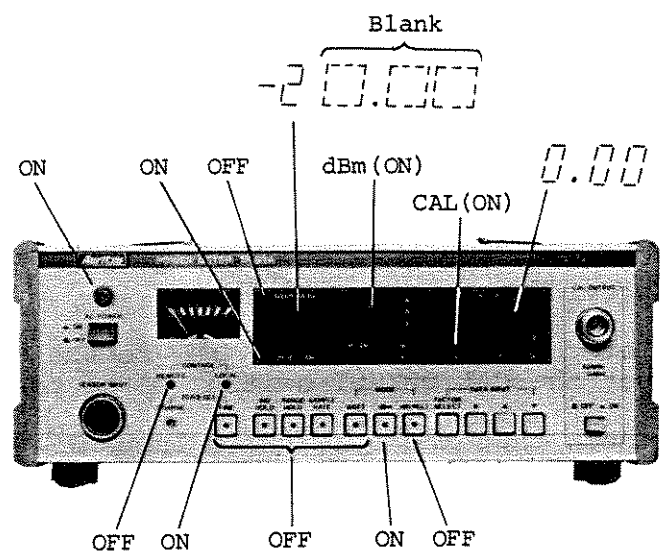

Fig. 4-3 Initialization

8. Set the CAL OUTPUT switch (6) to the OFF position.
- Note: When the MA72A/B sensor is used, perform STEPS 9 through 24. When the MA73A sensor is used, perform STEPS 25 through 40.
9. Connect the MA72A/B sensor to the CAL OUTPUT connector (5).

STEP

PROCEDURE

10. Turn the ZERO SET COARSE control (12) with a screwdriver so that the pointer of the peaking meter (17) is located in the leftmost range of the scale.

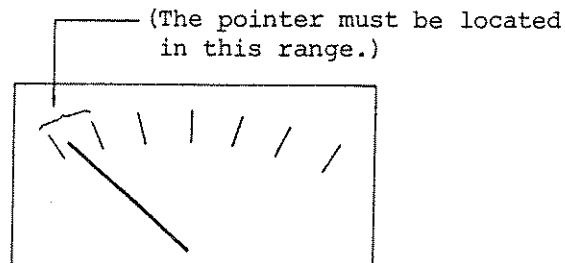

11. Press the ZERO SET FINE key (12) and check that the LED inside the key is on for approx. 7 seconds and that the output from the ZERO SET SIGNAL OUTPUT (21) is set to TTL low-level (approx. 0 V). This output is usually at the TTL high-level (approx. 5 V).) Also check that digital display (1) is in the WATT mode, and that zero adjustment ($0.0 \pm 0.1 \mu\text{W}$) is performed.

When the LED goes out, the display returns to its previous status.

12. Set the RANGE HOLD key (10) to the ON position and set the CAL OUTPUT switch (6) to the ON position.

Check that the OVER RANGE lamp (19) lights up and that "-1 . dBm" is displayed at (1).

Note: indicates a blank.

13. Set the RANGE HOLD key (10) to the OFF position. Check that digital display (1) shows approx. 0 dBm.



14. Press the WATT key (8) and check that digital display (1) shows approx. 1 mW.

15. Check that the output voltage from the RECORDER OUTPUT (20) at the rear panel is approx. 1 Vdc.

16. Press the dBm key (8) and the key (7). The digit in the ten's position of the FACTOR display (4) blinks on and off. Press the and keys (7) and check that the range of the digit is between 0 and 7.

STEP

PROCEDURE

17. Each time the  key (7) is pressed, the blinking  digit in the FACTOR display (4) moves to the right. Check that the range of each digit varies between 0 and 9.
18. Press the FACTOR SELECT key (7) and check that the LOSS lamp in the FACTOR display (4) lights up.
19. Press the FACTOR SELECT key (7) again. Check that the LOSS lamp is off and the GAIN lamp is on.
20. Press the FACTOR SELECT key (7) again and check that the FACTOR display (4) shows a blank.
21. Set the dB (REL) key (8) to ON. Check that the digital display (1) shows +0.00 dB (REL).
22. Set the IND HOLD key (11) to ON. Check that the indication cannot be changed by operating other keys while this status is effective.
23. Set the IND HOLD key (11) to OFF and press the SAMPLE RATE key (9) once. Check that the LED inside the key blinks on and off at intervals of approx. 1.5 seconds. Press the SAMPLE RATE key again, and check that the LED blinks on and off at intervals of approx. 3 seconds. Press this key again and check that the LED blinks on and off at intervals of approx. 6 seconds. Pressing this key again should cause the LED to go off.

This shows that the RF input is averaged and measured while the LED is on. This function is useful when measuring a signal containing a lot of noise.
24. Press the dBm key (8). Using the DATA INPUT keys (7), return the data (in the CAL memory) to 0.00 dB.
25. Connect the MA73A Sensor to the CAL OUTPUT connector (5) through the MP47A 30 dB attenuator.
26. Turn the ZERO SET COARSE (12) with a screw driver so that the pointer on the peaking meter (17) is located in the leftmost range of the scale.

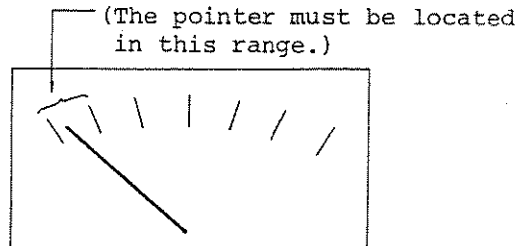

27. Press the ZERO SET FINE key (12) and check that the LED inside the key lights up for approx. 7 seconds and that the output from the ZERO SET SIGNAL OUTPUT connector (21) is set to the TTL low-level (approx. 0 V). (Normally, this output is at the TTL high-level (approx. 5 V).) Also check that the digital display (1) is in the WATT mode and that the zero adjustment (0.00 nW) is performed. But the minimum digit fluctuates a little by the influence of noise.



When the LED was goes off, the display returns to its previous status.

28. Set the RANGE HOLD key (10) to ON and set the CAL OUTPUT switch (6) to ON.

Check whether or not the OVER RANGE lamp (19) lights up and that "-5 . dBm" is displayed at (1).

Note: indicates a blank.

29. Set the RANGE HOLD key (10) to OFF. And check that digital display (1) shows approx. -30 dBm.
30. Press the WATT key and check that digital display (1) shows approx. 1 μ W.
31. Check that the output voltage from the RECORDER OUTPUT (20) at the rear panel is approx. 1 V dc.
32. Press the dBm key (8) and the key (7) and check that the digit in the ten's position of the FACTOR display (4) blinks. Press the or key (7), check that the digit varies from 0 to 7.

STEP	PROCEDURE
33.	Each time the  key (7) was pressed, the blinking  digit in the FACTOR display (4) moves to the right. Check that each digit varies from 0 to 9.
34.	Press the FACTOR SELECT key (7) and check whether or not the LOSS lamp in FACTOR display (4) lights up.
35.	Press the FACTOR SELECT key again and check that the LOSS lamp goes off, the GAIN lamp lights up.
36.	Press the FACTOR SELECT key again, and check that the FACTOR display (4) shows a blank.
37.	Set the dB (REL) key (8) to ON and check that digital display (1) shows +0.00 dB (REL).
38.	Set the IND HOLD key (11) to ON and make sure that the indication cannot be changed by operating other keys while this status is effective.
39.	Set the IND HOLD key (11) to OFF and press the SAMPLE RATE key (9) once. Check that the LED inside the key blinks on and off in at intervals of approx. 1.5 seconds. Press the SAMPLE RATE key (9) again and check that the LED blinks on and off at intervals of approx. 3 seconds. Press this key again and check that the LED blinks on and off at intervals of approx. 6 seconds. Pressing this key again should cause the LED to go off. This shows that the RF input is averaged and measured while the LED is on. This function is useful when measuring a signal containing a lot of noise.
40.	Press the dBm key (8). Using the DATA INPUT keys (7), return the data (in the CAL memory) to 0.00 dB.

4.6 Measurement

Power can be measured in the following procedure:

STEP	PROCEDURE
1.	Set the AC power switch (14) to the OFF position.
2.	Set the AC/DC switch (22) to the AC position.
3.	Check that the power voltage is $\boxed{**}$ Vac $\begin{matrix} +10\% \\ -15\% \end{matrix}$ and that the appropriate fuses have been set.
4.	Connect a 3-conductor power cord to the AC power line through the AC power receptacle. Note: If a 3-conductor power cable is not available, ground the grounding terminal (26) located on the rear panel of the ML83A to prevent electrical shock.
5.	Connect a sensor to the SENSOR INPUT connector (13) with the sensor connecting cable.
6.	Set the AC power switch (14) to the ON position.
7.	Set the CAL OUTPUT switch (6) to the OFF position. (See Paragraphs 4.5 (2) and (3) for use of the MZ95A battery pack or external DC power.
8.	Turn the SET COARSE control (12) with a screwdriver so that the pointer of the peaking meter (17) is located in the leftmost range of the scale.

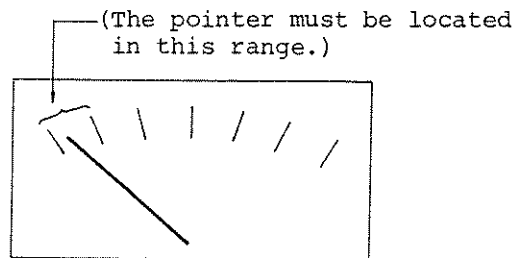

Note: While zero adjustment is being performed, do not apply RF input to the sensor. Zero adjustment cannot be performed correctly if it is.

STEP

PROCEDURE

9. Press the ZERO SET FINE key (12) and check that the LED inside the key is on for approx. 7 seconds while the auto zero loop circuit performs the zero adjustment and the digital display (1) shows $0.0 \pm 0.1 \mu\text{W}$.

When the zero adjustment has been completed, this LED goes off.

Note: STEPS 10 through 13 explain how to calibrate the MA72A/B or MA73A Sensor.

The millimeter wave band MP Sensor can be calibrated using a calibrated calorie meter; Section 4.7 explains millimeter wave band sensor calibration.

10. Connect the sensor to the CAL OUTPUT connector (5). When the MA72A/B Sensor is used, connect it directly. When the MA73A Sensor is used, connect it through the MP47A 30 dB attenuator.

Then, set the CAL OUTPUT switch (6) to the ON position.

11. Read the REFERENCE FACTOR (CAL FACTOR value at 50 MHz) printed on the sensor. Enter the REFERENCE FACTOR into the CAL FACTOR memory with the DATA INPUT keys (7).
Setting example: When the REFERENCE FACTOR printed on the sensor is 0.34 dB, follow this procedure:

- (i) Press the FACTOR SELECT key (7) and check that the CAL lamp in FACTOR display (4) lights up.
- (ii) Pressing the \blacktriangleright key three times causes the first digit after the decimal point to blink in the FACTOR display (4). Using the \blacktriangle , \blacktriangledown keys, set the FACTOR display to 0.30 dB.
- (iii) Press the \blacktriangleright keys again, and set the second digit display after the decimal point to 0.34 dB with the \blacktriangle , \blacktriangledown keys.
This completes the REFERENCE FACTOR setting.

STEP

PROCEDURE

12. Adjust the sensor sensitivity using a screwdriver so that digital display (1) shows 0.00 dBm (when the MA72A/B Sensor is used) or -30.00 dBm (when the MA73A Sensor is used).

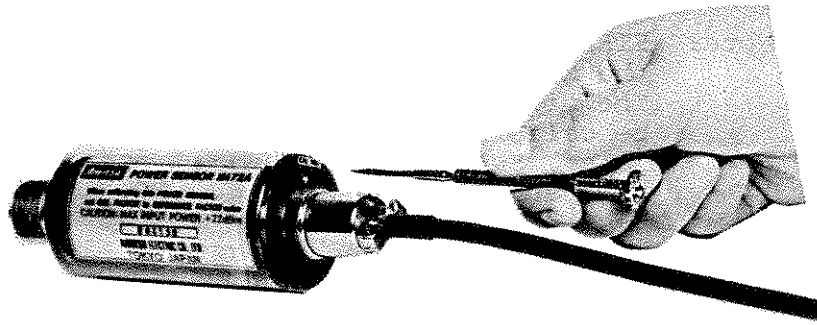

13. Set the CAL OUTPUT switch (6) to the OFF position and disconnect the sensor from the CAL OUTPUT connector (5).
14. From the calibration curve printed on the sensor, determine the calibration factor value at the measurement. Enter the calibration value into the CAL FACTOR memory using the DATA INPUT keys (7).
Setting example: The calibration curve shown on the left is printed on the sensor and the measurement is to be taken at a frequency of 2 GHz.

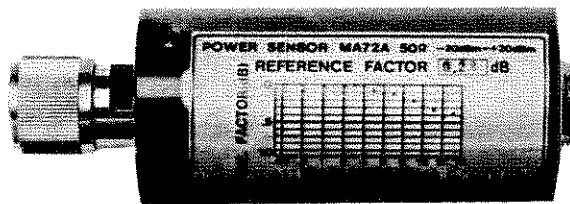

- (i) Read the calibration factor value for 2 GHz from the calibration curve. In this case, assume that this value is 0.25 dB.

STEP

PROCEDURE

- (ii) Press the FACTOR SELECT key (7) so that the CAL lamp in FACTOR display (4) blinks.
- (iii) Press the \blacktriangleright key and check that the ten's digit of the FACTOR display blinks. Press the \blacktriangleright key twice and check that the first digit after the decimal point blinks. Using the \blacktriangle , \blacktriangledown keys, set the FACTOR display to 0.20 dB.
- (iv) Press the \blacktriangleright key again and set the second digit after the decimal point to 0.25 dB by using the \blacktriangle , \blacktriangledown keys. This completes the calibration value setting.

Note: If an RF power exceeding the maximum input power is applied directly to the sensor, the sensor and the ML83A power meter may be damaged.

The maximum input power for each sensor is shown in Table 2-4.

15. When an attenuator or amplifier is inserted between the sensor and the RF power source to be measured, use the DATA INPUT keys (7) to set a LOSS FACTOR value (for the attenuator) or a GAIN FACTOR value (for the amplifier).

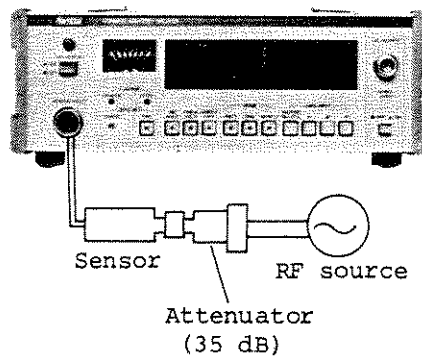

STEP	PROCEDURE
------	-----------

15. Setting example: When a 35 dB attenuator is inserted between the sensor and the RF source, follow this procedure.

- (i) Press the FACTOR SELECT key (7) to turn on the LOSS lamp in FACTOR display (4).
- (ii) Press the \blacktriangleright key so that the ten's digit in the FACTOR display blinks. Use the \blacktriangle , \blacktriangledown keys to set the display to to 30.00 dB.
- (iii) Press the \blacktriangleright key again so that the unit digit in the FACTOR display blinks. Use the \blacktriangle , \blacktriangledown keys to set the display to 35.00 dB.
- (iv) After this, the applied RF power can be directly measured.

16. Connect the RF input power (to be measured) to the sensor.

Note: If the RF input level is not appropriate, the following alarm information appears on digital display (1).

i) • OVER RANGE
+2 . dBm

... Indicates that the RF input level is higher than the upper limit of the measurement power range.

When RANGE HOLD is being used, "+2", "+1", "0" or "-1" is displayed, corresponding to the range being used.

STEP	PROCEDURE
16.	<p data-bbox="630 260 1024 291">ii) -2 [] . [] [] . dBm</p> <ul style="list-style-type: none"> <li data-bbox="704 323 932 344">• UNDER RANGE <p data-bbox="737 401 1451 485">... Indicates that the RF input level is lower than the lower limit of the measurement power range.</p> <p data-bbox="802 516 1451 632">When RANGE HOLD is being used, "+1", "0", "-1", or "-2" is displayed, corresponding to the range being used.</p> <p data-bbox="607 659 1024 690">iii) +9 [] . [] [] . dBm</p> <p data-bbox="732 722 1127 806">Neither the OVER RANGE lamp nor the UNDER RANGE lamp lights up.</p> <p data-bbox="737 858 1451 974">... Indicates that the RF input level is within the measurable power range, but the value stored in the FACTOR memory is too large.</p>
17.	<p data-bbox="516 1010 1430 1094">Select the units of measurement by pressing the dBm or WATT key (8). When the current range is to be fixed, set the RANGE HOLD key (10) to ON.</p> <p data-bbox="516 1125 1390 1209">A measured value is displayed directly on digital display (1). The approximate analogue value is indicated by the peaking meter (17).</p>
18.	<p data-bbox="516 1251 1443 1419">When a relative value of the measured power is to be displayed, press the dB (REL) key (8). Pressing this key sets digital display (1) to 0.00 dB, that is, the value just measured is stored as a reference value. In a later measurement, a relative value from the reference value is displayed in dB units.</p>
19.	<p data-bbox="516 1461 1349 1598">If noise causes too great a fluctuation in the digital display (1), press the BLANKING switch (2) to delete the lowest digit of the display or press the SAMPLE RATE key (9) to average the measured data.</p>

4.7 Calibration of Millimeter Wave Band Sensor MP

When the MP Sensor is used, the DC e.m.f.* resulting from the application of a low-frequency power is not always equal to the DC e.m.f. which results when the same power is applied at RF. Therefore, the instruments shown in Table 4-2 are required to calibrate the MP sensor.

* e.m.f. is electromotive force

Table 4-2 Instruments Required for Millimeter Wave Band Sensor Calibration

- Millimeter wave band signal generator
(Maximum output power: 20 mW or higher)
- Cavity-resonator frequency meter
- Rotary-type variable attenuator
(Attenuation: 15 dB or more, VSWR: 1.15 or less)
- Standard power meter
The power meter calibrated at 34 GHz by using a calorie meter substandard which was calibrated at 34 GHz by the Electro-technical Laboratory in Japan.
A taper waveguide having attenuation calibrated is provided with the meter.

The MP sensor can be calibrated in the following procedure:

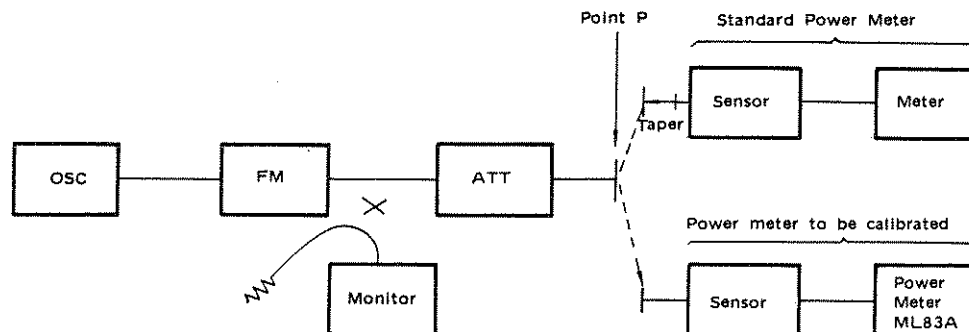

Fig. 4-4 Block Diagram of Sensor Calibration

- ① Using the cavity-resonator frequency meter, set the oscillation frequency of the millimeter wave band signal generator to the reference frequency. For example, set it to the middle frequency of the frequency band used by the sensor.
- ② Using the standard power meter, measure the power at point P shown in Fig. 4-4, and set the attenuator so that the measured value is 1 mW (0 dBm).
- ③ Disconnect the standard power meter from point P and connect the sensor of the power meter which is to be calibrated. Adjust and set the CALIB in the sensor so that the power meter being calibrated indicates 1 mW.

Note: Adjustment of the CAIB in the sensor must be performed by removing an outer case.

The outer case, however, should not be removed as long as no calibration is performed.

- ④ For other frequencies, apply the 1 mW power, which was calibrated with the standard power meter, to the power meter being calibrated. Then plot a calibration curve using the value indicated by the power meter being calibrated.

SECTION 5
GPIB (OPTIONAL UNIT)

5.1 Outline

The GPIB, an optional unit for the ML83A power meter, is an interface bus developed based on IEEE-488-STD and is mounted in the ML83A cabinet.

When an ML83A power meter with the GP-IB interface is connected to a controller having the GP-IB interface functions, automatic program measurement can be performed. Also, when such an ML83A is connected to a data output device having the listener function (e.g., a printer), measured power values can be recorded.

5.2 Interface Function

Using the GPIB interface, the ML83A power meter can be externally controlled, except for the power switch ON/OFF setting, CAL OUTPUT ON/OFF setting, COARSE zero setting, and FACTOR Setting.

Table 5-1 is a list of the ML83A interface functions.

Table 5-1 ML83A Interface Functions

Function	Description
SH1	Completes source handshake functions
AH1	Completes acceptor handshake functions
L2	Basic listener function The listener function can be released by MTA.
T7	Basic talker function Talk-only mode The talk function can be released by MLA.

Table 5-1 ML83A Interface Functions (Cont)

Function	Description
SRO	Not including the service request function
RL1	Including the remote operation/local operation selecting function
PP0	Not including the parallel pole function
DC1	Including the device clear function
DT0	Not including the device trigger function
CO	Not including the control function

5.3 GPIB System Outline

The GPIB system electrically and mechanically standardizes the interface for devices having diverse functions, connects the devices to a single bus line and transmits data among devices through this bus line.

5.3.1 Outline

Fig.5.1 is a block diagram of the GP-IB system.

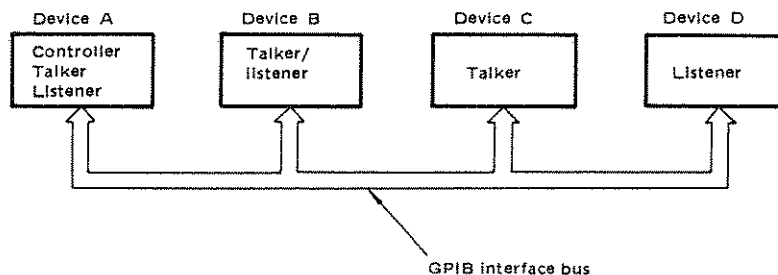

Fig.5.1 GPIB System Block Diagram

Four devices are connected in the example in Fig.5.1. However, this interface bus system can connect a maximum of 15 devices.

The functions of the devices can be classified into three groups, with each device able to belong to any group.

a) Controller

This controls the overall system. A computer or calculator generally has this function.

The controller is capable of specifying itself or other devices as the listener and talker.

Two or more controllers may be attached to one bus system, but only one can be operated as the controller at any one time.

b) Talker

This is any device with the ability to send data to other devices. This function is enabled only when the device is specified as a talker. There cannot be two or more talkers at the same time on one bus system.

c) Listener

This is a device with the ability to receive data from a talker. This function is enabled only when the device has been specified as a listener.

There may be more than one listener on one bus system.

The three system elements have been described above. However, the actual devices often have all these functions. For example, a calculator can be operated as a controller, talker, and listener at different times.

5.3.2 Description of Bus Line

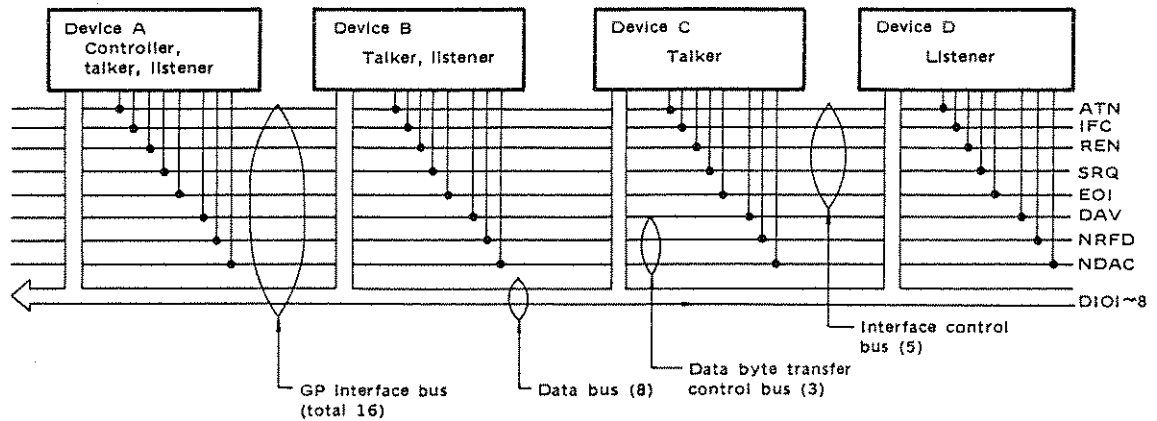

Fig.5.2 Construction of Bus Line

As shown in Fig.5.2, the bus line consists of 16 signal lines functionally divided into the following three buses:

1) Data bus (DI01 to DI08)

This bus consists of 8 signal lines and is used to transfer data between devices and to send various commands from the controller to the other devices. The data and command transfer takes place in bit-parallel, byte-serial format.

2) Data byte transfer control bus (DAV, NRFD, NDAC)

This bus consists of 3 signal lines and is used to send messages placed on the data bus by the talker to the listener.

The process of sending data by means of these three signal lines is called "3-wire handshake."

The role of each of these three signals lines is as follows:

○ DAV (Data Valid)

This line indicates that the data on the data

bus is effective. This line is controlled by the controller or talker.

○ NRFD (Not Ready For Data)

This signal line indicates that the listener is not ready to receive the data on the data bus. This line is controlled by the listener.

○ NDAC (Not Data Accepted)

This line indicates that the listener has not accepted the data on the data bus. It is controlled by the listener.

3) Interface control bus (ATN, IFC, REN, SRQ, EOI)

This bus consists of five signal lines and is concerned with control of the overall bus system. The operation of each signal line is given below.

○ ATN (Attention)

This line controls the controller and determines the meaning of the data on the data bus. It discriminates between commands or addresses and data.) When this line is TRUE, the data on the data bus is an address or a command and all the devices must receive data by participating in the 3-wire handshake.

When this line is FALSE, the data on the data bus is general data and only the specified (addressed) devices participate in the 3-wire handshake and transfer data. At this time, the other devices have no effect on the operation.

○ IFC (Interface Clear)

This line sets the initial conditions and is controlled by the controller.

REN (Remote Enable)

This line is controlled by the controller and is

used to control whether the devices are remote or local in accordance with other messages (commands).

- SRQ (Service Request)

This line is used when an interrupt is issued to the controller. Each device controls this line.

- EOI (End or Identify)

This line is used to indicate the end of transfer of several bytes of data. It is controlled by the talker.

5.3.3 Three-Wire Handshake

As previously described, the three lines DAV, NRFD and NDAC are used to reliably transfer data and commands between devices. The relationship between these three lines and the devices is shown in Fig.5.3 (Timing Chart) and Fig.5.4 (Flow Chart).

The GP-IB bus logic and signal names will be described here as necessary precautions regarding Fig.5.3 and Fig.5.4. The GP-IB bus uses negative logic. That is, LOW level indicates that a signal is present. For example, when DAV (Data Valid) is LOW level, it indicates that the data to be transferred is on the bus line.

However, on the 16 signal lines, NRFD (Not Ready For Data) and NDAC (Not Data Accepted) are functionally positive logic. When NRFD is HIGH level, for example, it indicates that the device is ready to accept data at RFD (Ready For Data). Therefore, if this is considered as negative logic, it has the opposite meaning at RFD and the function of the line becomes Not Ready For Data (NRFD) at LOW level.

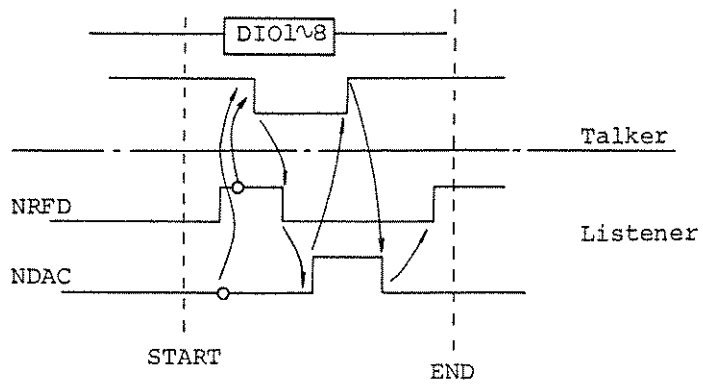
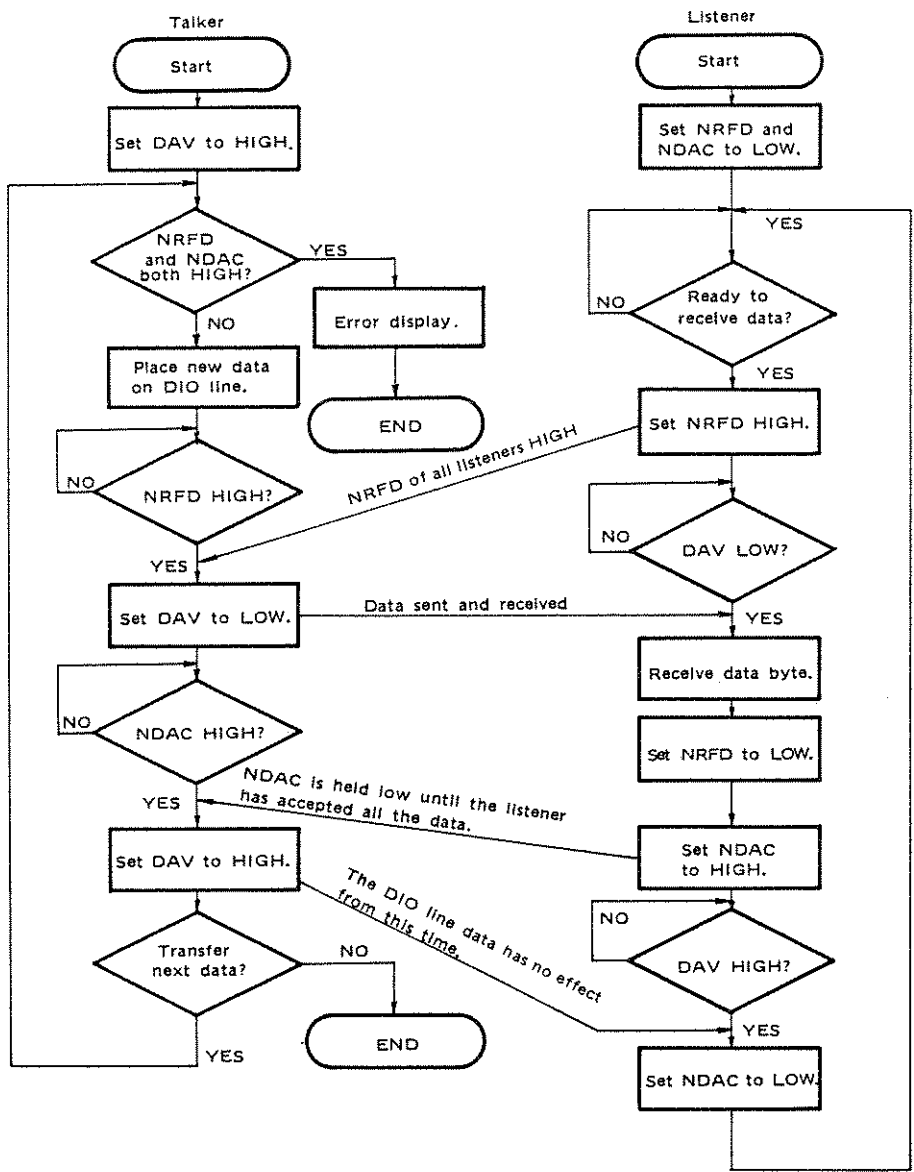

Fig.5.3 Three-Wire Handshake Timing Chart



This handshake is performed one time, each time the talker sends data to the listener. DAV is controlled by the talker, and NRFD and NDAC are controlled by the listener.

Fig.5.4 Three-Wire Handshake Flow Chart

5.4 Handling

5.4.1 Setting Address Switch

A unique address is assigned to any instrument connected to the GP-IB, and its address is designated by an address switch to select the instrument for use from among the other instruments on the GP-BUS. An address code generally consists of 7 bits.

The address code of the ML83A, however, consists of 6 bits in which the high-order bit, bit 7, has been omitted.

When the address switch of bit 6 has been set to ON, the instrument operates in TALK ONLY mode. When set to the OFF position, the switch consisting of the other five bits is used as address to identify the instrument.

	b6	b5	b4	b3	b2	b1
ONLY	ON					
		A5	A4	A3	A2	A1
NOT ONLY	OFF					

On each instrument A5 through A1 is set and whether or not the combination of bits b5 through b1 of the address code from the controller match this bit configuration is monitored.

When they match, the instrument is set to a talker according to the combination of bits 6 and 7.

The address of this instrument is set by the address switch on the rear panel.

The instrument addresses can be selected within the range shown in Note 1 and Note 2 of the ASCII code table of Table 5.2. However, codes in which bit 1 through bit 5 are all "1" cannot be used since they have been designated the unlisten or untalk commands.

Table 5-2 USA Standard Code for Information Interchange (ASCII)

BITS					0 0	0 0 1	0 1 0	0 1 1	1 0 0	1 0 1	1 1 0	1 1 1	Note 3
b ₄	b ₃	b ₂	b ₁	Column Row	0	1	2	3	4	5	6	7	
0	0	0	0	0	NUL	DLE	SP	0	@	P	-	P	
0	0	0	1	1	SOH	DC1		1	A	Q	a	q	
0	0	1	0	2	STX	DC2	"	2	B	R	b	r	
0	0	1	1	3	ETX	DC3	#	3	C	S	c	s	
0	1	0	0	4	EOT	DC4	\$	4	D	T	d	t	
0	1	0	1	5	ENQ	NAK	%	5	E	U	e	u	
0	1	1	0	6	ACK	SYN	&	6	F	V	f	v	
0	1	1	1	7	BEL	ETB	'	7	G	W	g	w	
1	0	0	0	8	BS	CAN	(8	H	X	h	x	
1	0	0	1	9	HT	EM)	9	I	Y	i	y	
1	0	1	0	10	LF	SUB	*	:	J	Z	j	z	
1	0	1	1	11	VT	ESC	+	;	K	[k	{	
1	1	0	0	12	FF	FS	,	<	L	\	l	;	
1	1	0	1	13	CR	GS	-	=	M]	m	}	
1	1	1	0	14	SO	RS	.	>	N	^	n	~	
1	1	1	1	15	SI	US	/	?	O	-	o	DEL	

Note 3

Note 1 Note 2

- Note 1: GP-IB valid LISTEN addresses
- Note 2: GP-IB valid TALK addresses
- Note 3: Logic 1=0 V

NOTE: Since bit 1 is ON in the address switch setting example of Fig. 5-5, the address shows "1".

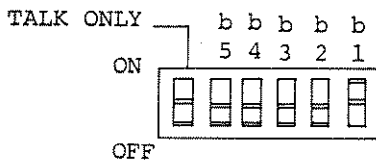

When the switch of bit 6 has been set to TALK ONLY side, the instrument functions as TALK ONLY.

Fig.5.5 Address Switch

5.4.2 Cable Connection

Up to a maximum of 15 devices can be connected to the GP-IB system. However, these are restrictions on the length of the connection cables which must be taken into account.

- a. Length of each cable must be 2 m or less.
- b. Overall length of cable must be 20 m or less.

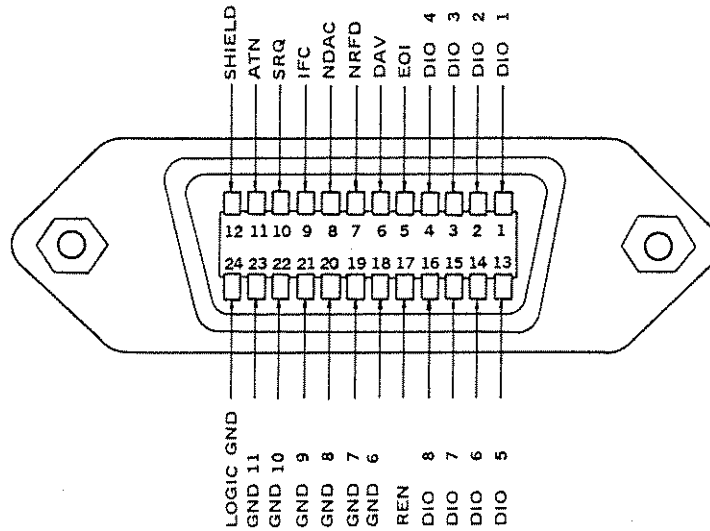

Fig.5.6 GP-IB Interface Connector Pin Arrangement

5.5 Programming Codes and Output Data Format

All codes are given in ASCII.

5.5.1 Programming Codes

The ML83A control program allows the use of the programming codes listed in Table 5.3.

Table 5.3 GP-IB programming codes

Function	Contents	Programming code
RANGE specification	<p>When the MA72A/B or MP <input type="checkbox"/> sensor is used</p> <p>RANGE HOLD</p> <ul style="list-style-type: none"> -10 dBm (100 μW) range G2 0 dBm (1 mW) range G3 +10 dBm (10 mW) range G4 +20 dBm (100 mW) range G5 <p>When the MA73A sensor is used</p> <ul style="list-style-type: none"> -50 dBm (10 nW) range G2 -40 dBm (100 nW) range G3 -30 dBm (1 μW) range G4 -20 dBm (10 μW) range G5 <p>AUTO RANGE G9*</p>	
MODE	<p>WATT MODE A</p> <p>dB (REL) MODE B</p> <p>dB (REF) (sets the reference value) C</p> <p>dBm MODE D*</p>	
SAMPLE RATE	<p>No averaging; measurements are output in about 0.3 second intervals. K*</p> <p>An average is calculated for each 5 measurements; the averages are output in about 1.5 second intervals. L</p>	

Table 5.3 GP-IB programming codes (cont'd)

Function	Contents	Programming code					
	<p>An average is calculated for each 10 measurements; the averages are output in about 3 second intervals.</p> <p>An average is calculated for each 20 measurements; the averages records are output in about 6 second intervals.</p>	<p>M</p> <p>N</p>					
ZERO SET	ZERO SET FINE SWITCH ON	Z					
FACTOR INPUT	Set CAL FACTOR.	FC					
	Set GAIN FACTOR.	FG					
	Set LOSS FACTOR.	FL					
	<p>Data format</p> <div style="text-align: center;"> </div> <p>The decimal point is assumed to be fixed at the third digit.</p> <p>(e.g.) Set CAL FACTOR to 0.5dB.</p> <div style="text-align: center;"> <table border="1"> <tr> <td>FC</td> <td>0</td> <td>0</td> <td>5</td> <td>0</td> </tr> </table> </div>	FC	0	0	5	0	
FC	0	0	5	0			
FACTOR** CLEAR	<p>Clear CAL FACTOR.</p> <p>Clear GAIN FACTOR.</p> <p>Clear LOSS FACTOR.</p> <p>Clear all FACTORS.</p>	<p>FIC</p> <p>FIG</p> <p>FIL</p> <p>FIA</p>					
Measurement mode	<p>HOLD</p> <p>Settling time trigger**</p> <p>Trigger**</p> <p>Free run**</p> <p>Settling time free run**</p>	<p>H</p> <p>T</p> <p>I</p> <p>R*</p> <p>V</p>					

*The functions marked with A are automatically selected when the power switch is turned on.

**Measurement rate can be selected only when remote control is active; this function is not available under local control. The following explains the contents of the six measurement rates.

a) FACTOR CLEAR

The corresponding FACTOR will display 0.00.

All clear allows all input values for FACTOR to be set to 0.00, and those displays are set to CAL. FACTOR.

b) Hold

The measurement results are only retained; they are not output.

c) Settling time trigger

Measurement is done only once, approximately 1 second after this code is input. The resulting data is output. This code is generally used for synchronous measurement.

d) Trigger

Measurement is done only once, immediately after this code is input. The resulting data is output. This code is generally used for synchronous measurement.

e) Free run

Measurement is done continuously, and the resulting data is also output continuously. This code is used for asynchronous measurement.

f) Settling time free run

Measurement is done in about 1 second intervals, and the resulting data is output. This code is used for asynchronous measurement.

5.5.2 Output Data Format

Fig.5.7 illustrates the ML83A GP-IB output data format. Each column is explained in Table 5.4.

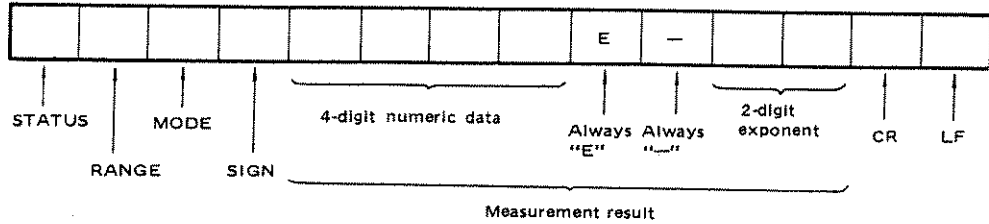

Fig. 5.7 GP-IB output data format

Table 5.4 GP-IB output data

Function	Contents	Output data
STATUS	Valid measurement result	P
	WATT mode under-range	Q
	Over-range	R
	dBm or dB (REL) mode under-range	S
	During automatic zero adjustment	T
	Zero could not be set during automatic zero adjustment. (Either RF power is applied to the sensor or the zero-setting loop was unsuccessful.)	V
	Note: Zero adjustment takes about 10 seconds.	
RANGE	When the MA72A/B or MP <input type="checkbox"/> sensor is used.	
	[-10 dBm (100 μW) range	J
	0 dBm (1 mW) range	K
	+10 dBm (10 mW) range	L
	[+20 dBm (100 mW) range	M
	When the MA73A sensor is used.	
	[-50 dBm (10 nW) range	J
	-40 dBm (100 nW) range	K
	-30 dBm (1 μW) range	L
	[-20 dBm (10 μW) range	M
MODE	WATT MODE	A
	dB (REL) MODE	B
	dB (REF) (Sets the reference level for dB (REL) mode)	C
	dBm MODE	D
SIGN	+ (Sign of the measurement value)	Space
	-	
MEASURED VALUE	Indicated as: n x 10 ^{-e} Where "n" is a 4-digit number and "e" is a 2-digit exponent.	

Note: CR and LF are output as terminator signals.

5.6 Operation Examples

The following gives several examples of automatic measurement with the ML83A.

5.6.1 Measurement in TALK ONLY Mode

When connected to an output device, such as a printer, that has the listener function, ML83A can output the measurement results automatically to the device.

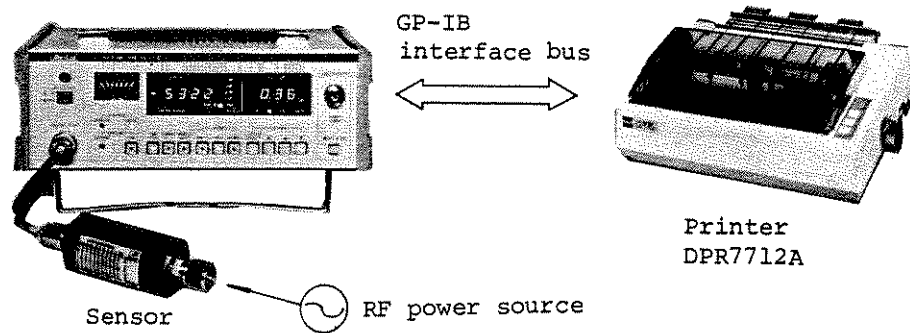

Fig. 5.8 Connecting ML83A to a printer

Suppose that the ML83A is connected to a printer, as shown in Fig. 5.8, and that the printer address is set to LISTENER ONLY and ML83A is set to TALK ONLY, as shown in Fig. 5.9. Then, the measurements are automatically output to the printer in the format shown in Fig. 5.7.

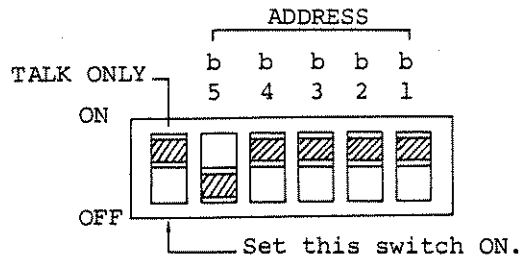

Fig. 4.9 Setting ML83A to TALK ONLY mode.

5.6.2 Automatic Measurement

The ML83A can be connected to a controller for a automatic measurement. Below are several examples in which the Anritsu Packet II Personal computer is used as the controller and the Anritsu DPR7712A printer is used as the output device. Fig. 5.10 shows how the computer and printer are connected to the ML83A, and Fig. 5.11 shows how the ML83A address is set.

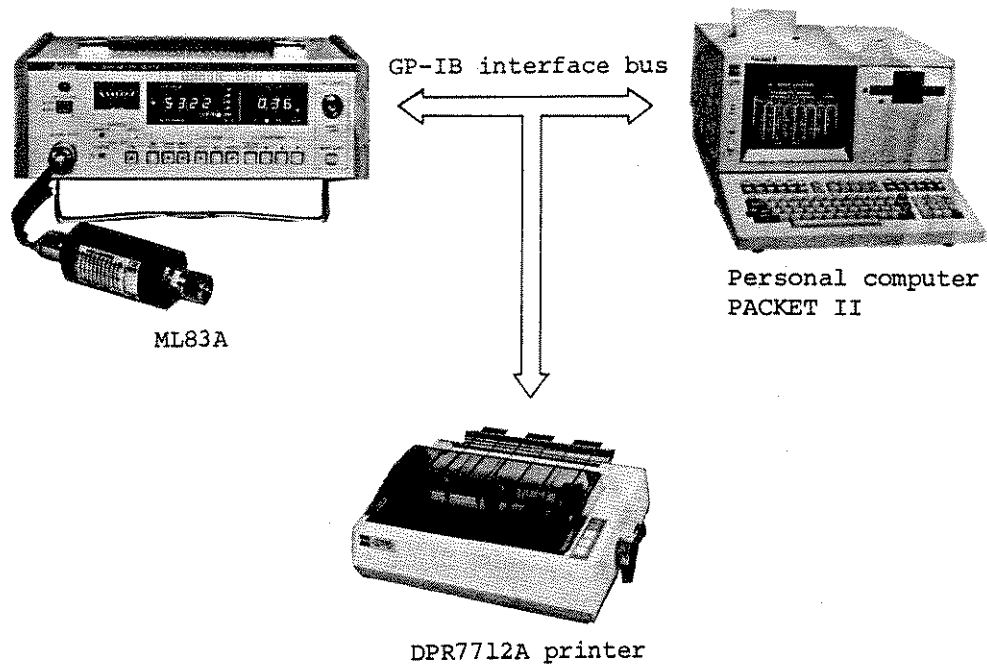

Fig. 5.10 Sample Configuration for Automatic Measurement

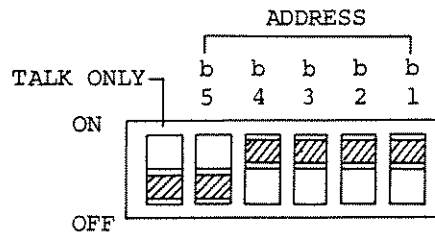

Fig. 5.11 Setting the ML83A Address for Automatic Measurement

As shown in Fig. 5.11, the ML83A address is set to 15 which corresponds to listen address / (slash) in ASCII notation (see Table 5.2). TALK ONLY switch is set to OFF.

Then, a program for automatic measurement is shown below.

After automatic zero adjustment, measurements are made in FREE RUN mode and the measured data are output to a printer. Subsequently, dB (REL) mode is set and the relative value is measured every one second and the result is output to a printer. Finally, again FREE RUN mode is set and switch over to LOCAL control is done at the end of the program.

Flow
chart

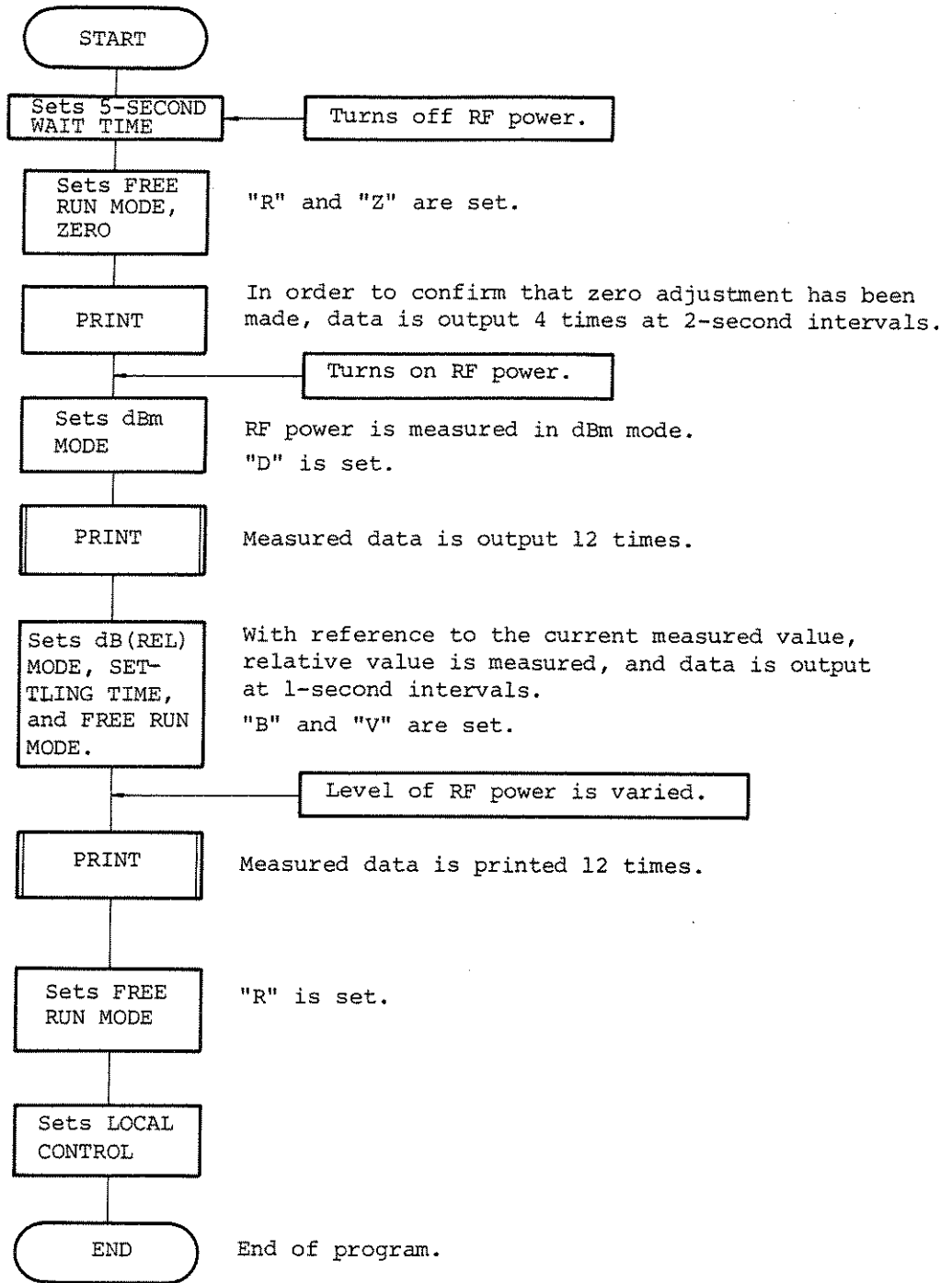

Program

10	REM ***"ML83AZRF" ZERO SET & TRIGGER MODE & FREE RUN ***	Gives program title
20	WAIT DELAY 5	Allows 5-second wait time to set RF power to OFF.
30	DIM A\$*50	Sets the length of string data for string variable A\$.
40	PRINTER IS @117	Sets the printer of address No. 17 for output.
50	PRINT	Performs line feed for easy reference of data.
60	WRITE @115:"R,Z"	Place the ML83A (set to address 15) in free run mode and automatic zero adjustment.
70	PRINT "ZERO SET"	Prints out the title of the data.
80	FOR K=1 TO 4 STEP 1	Repeats the line numbers 80 to 120 loop four times.
90	WAIT DELAY 2	Allows 2-second wait time.
100	READ @115:A\$	Reads the measured data from the ML83A.
110	PRINT "ΔΔ"; A\$	Prints data after two spaces.
120	NEXT K	Returns controls to line number 80 until the above FOR-NEXT loop has been done 4 times.

Program

130	PRINT	Performs line feed.
140	WRITE @115; "D"	Sets the ML83A to dBm mode.
150	PRINT "DBM SET"	Titles the data
160	GO SUB 240	Executes the line numbers 240 to 310 print subroutine.
170	PRINT	Performs line feed.
180	WRITE @115:"B,V"	Sets the ML83A to dB (REL) mode and the measurement mode to settling time free run mode.
190	PRINT "REL MODE & FREE RUN WITH SETTling TIME"	Titles the output data
200	GO SUB 240	Executes the line numbers 240 to 310 print subroutine.
210	WRITE @115:"R"	Returns the ML83A to free run mode.
220	LCL @115	Sets the ML83A to local operation.
230	GO TO 320	Jumps to line number 320 for the end of program.

The statements from line number 240 to 310 are provided for the print subroutine.

240	FOR J=1 TO 3	Repeats the line number 240 to 300 loop three times.
-----	--------------	--

Program

250 FOR K=1 TO 4	Repeats the line number 250 to 280 loop four times.
260 READ @115:A\$	Prints out the measured data of ML83A.
270 PRINT " ";A\$;	Prints data after two spaces.
280 NEXT K	Returns controls to line number 250 until the nested FOR-NEXT loop has been done four times.
290 PRINT	Performs line feed.
300 NEXT J	Returns controls to line number 240 until the outer FOR-NEXT loop has been done three times.
310 RETURN	Ends the print subroutine.
320 END	End of program.

